

102292 FAG

Angular contact ball bearings

TYPE: Ball bearings, Angular contact ball bearing, Double row, Hub bearing (unit), FAG production, generation 3

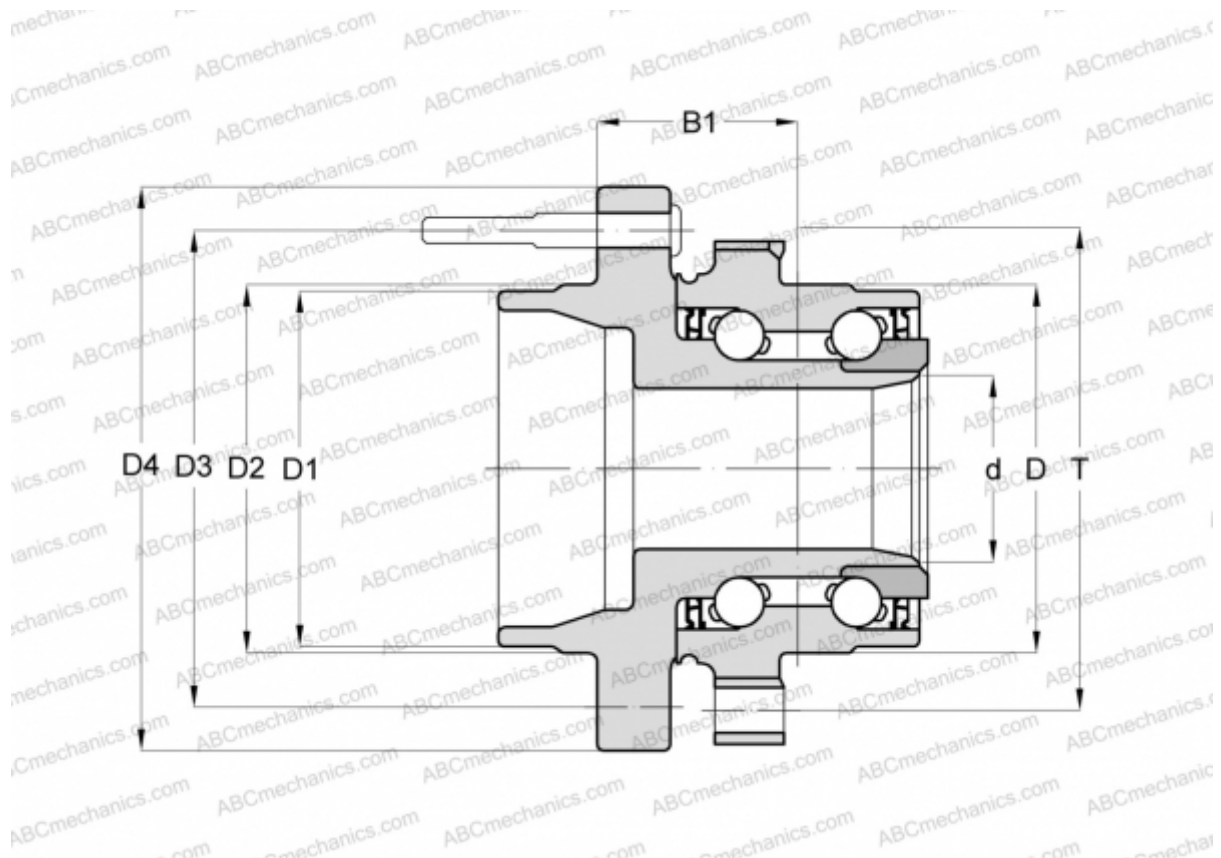

Technical specification

DIMENSIONS, MM

D	100,000
D1	61,500
D2	71,400
D3	127,000
D4	165,000
B1	51,900
T	120,500

MANUFACTURER

[FAG](#)