

## 102296 FAG

Angular contact ball bearings

TYPE: Ball bearings, Angular contact ball bearing, Double row, Hub bearing (unit), FAG production, generation 3

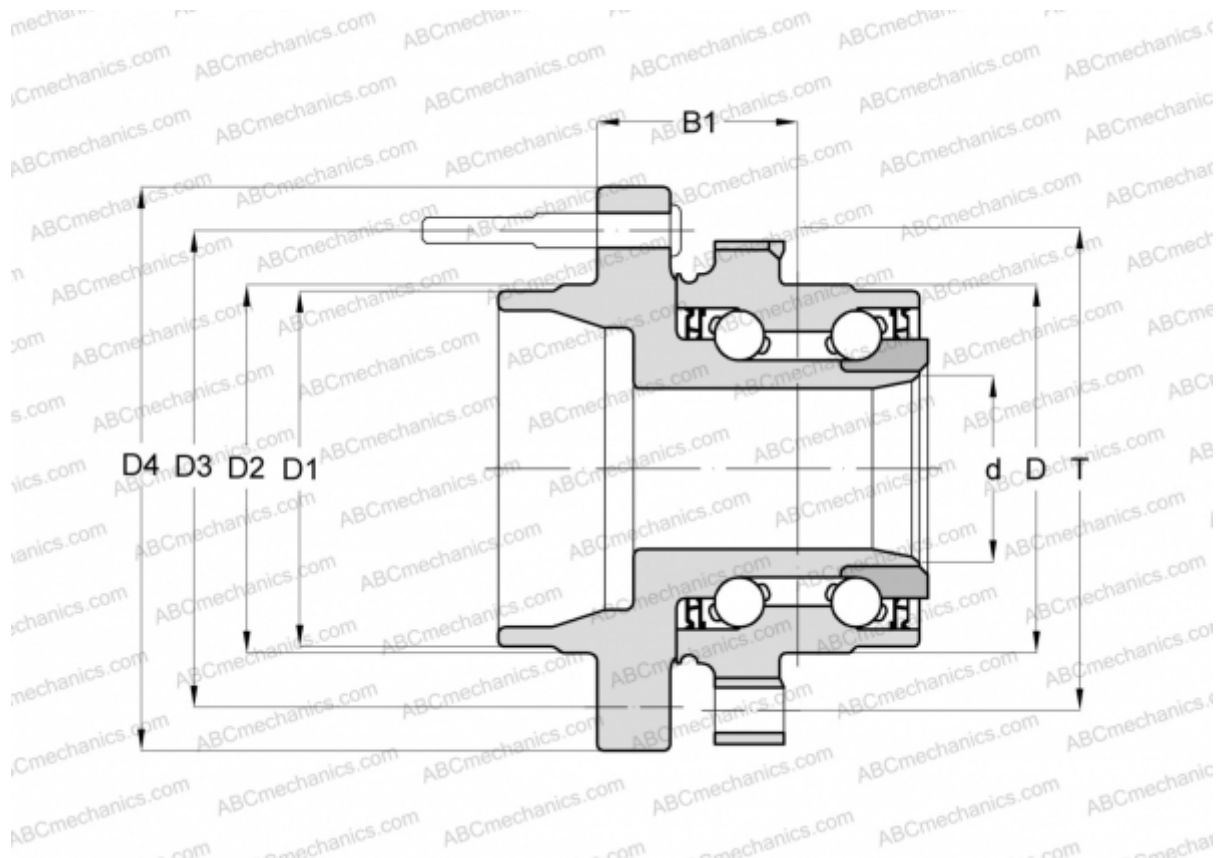

### Technical specification

#### DIMENSIONS, MM

D	93,000
D1	66,000
D2	68,000
D3	114,300
D4	136,000
B1	40,700
T	120,000

#### MANUFACTURER

[FAG](#)