

102299 FAG

Angular contact ball bearings

TYPE: Ball bearings, Angular contact ball bearing, Double row, Hub bearing (unit), FAG production, generation 3

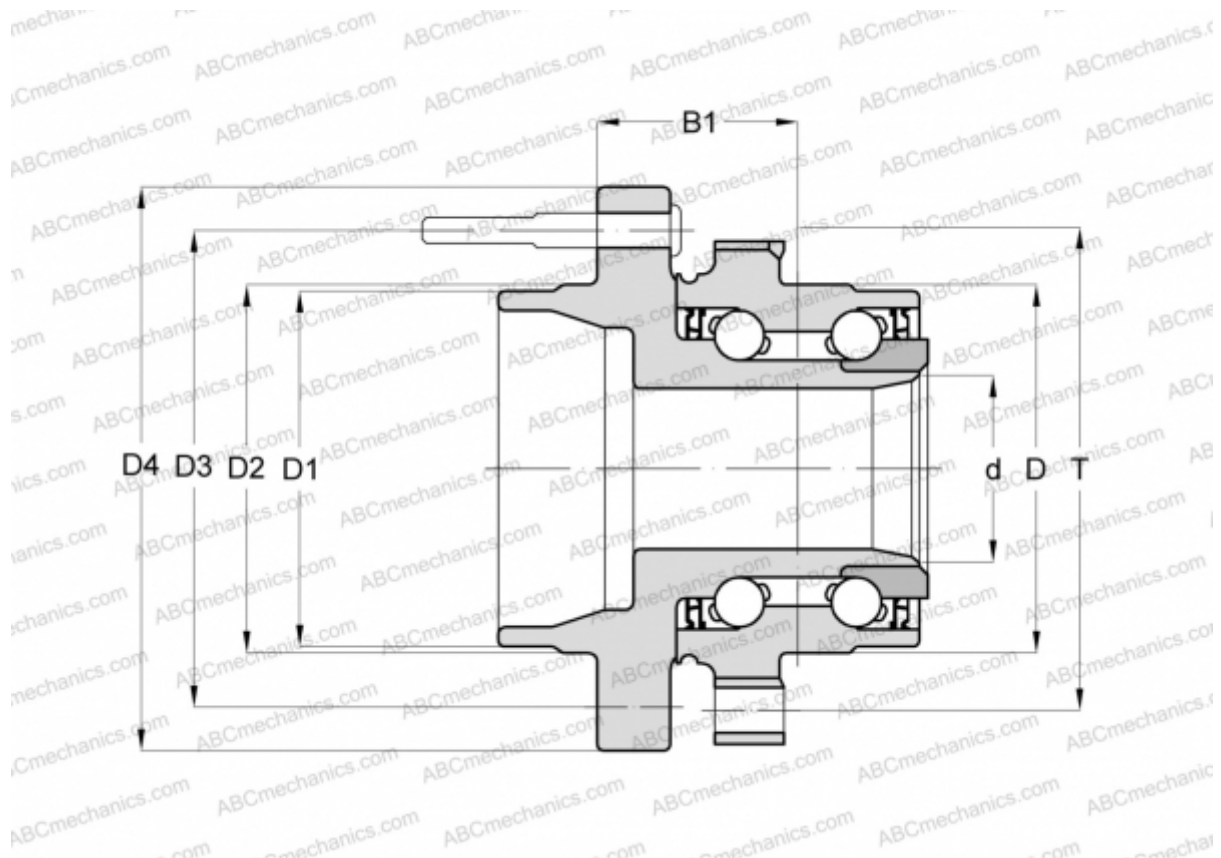

Technical specification

DIMENSIONS, MM

D	92,930
D1	66,300
D2	68,200
D3	115,000
D4	136,070
B1	41,000
T	120,000

MANUFACTURER

[FAG](#)