

## 102336 FAG

Angular contact ball bearings

TYPE: Ball bearings, Angular contact ball bearing, Double row, Hub bearing (unit), FAG production, generation 3

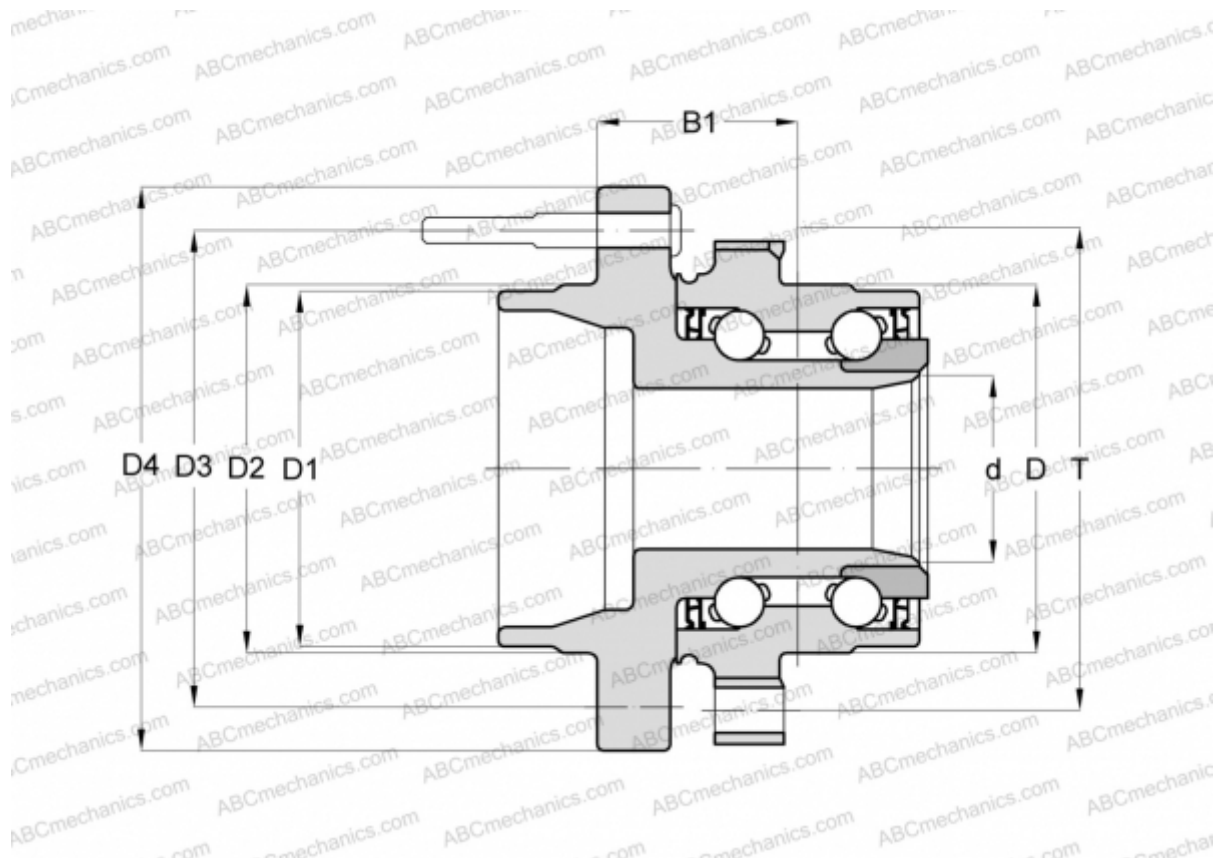

### Technical specification

#### DIMENSIONS, MM

D	83,900
D1	66,100
D2	69,300
D3	114,300
D4	138,400
B1	69,500
T	104,700

#### MANUFACTURER

[FAG](#)