

102339 FAG

Angular contact ball bearings

TYPE: Ball bearings, Angular contact ball bearing, Double row, Hub bearing (unit), FAG production, generation 3

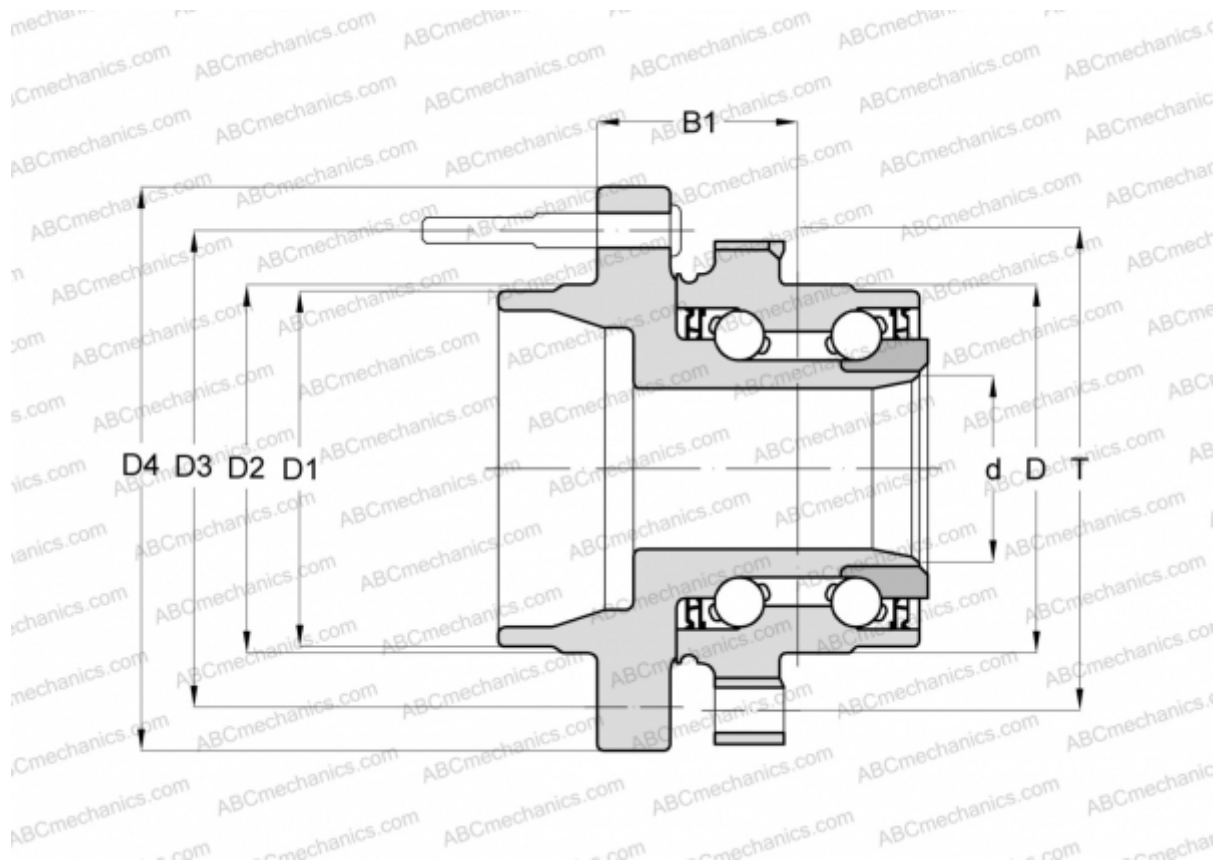

Technical specification

DIMENSIONS, MM

D	74,000
D1	54,000
D2	55,000
D3	100,000
D4	135,000
B1	60,000
T	97,660

MANUFACTURER

[FAG](#)