

102345 FAG

Angular contact ball bearings

TYPE: Ball bearings, Angular contact ball bearing, Double row, Hub bearing (unit), FAG production, generation 3

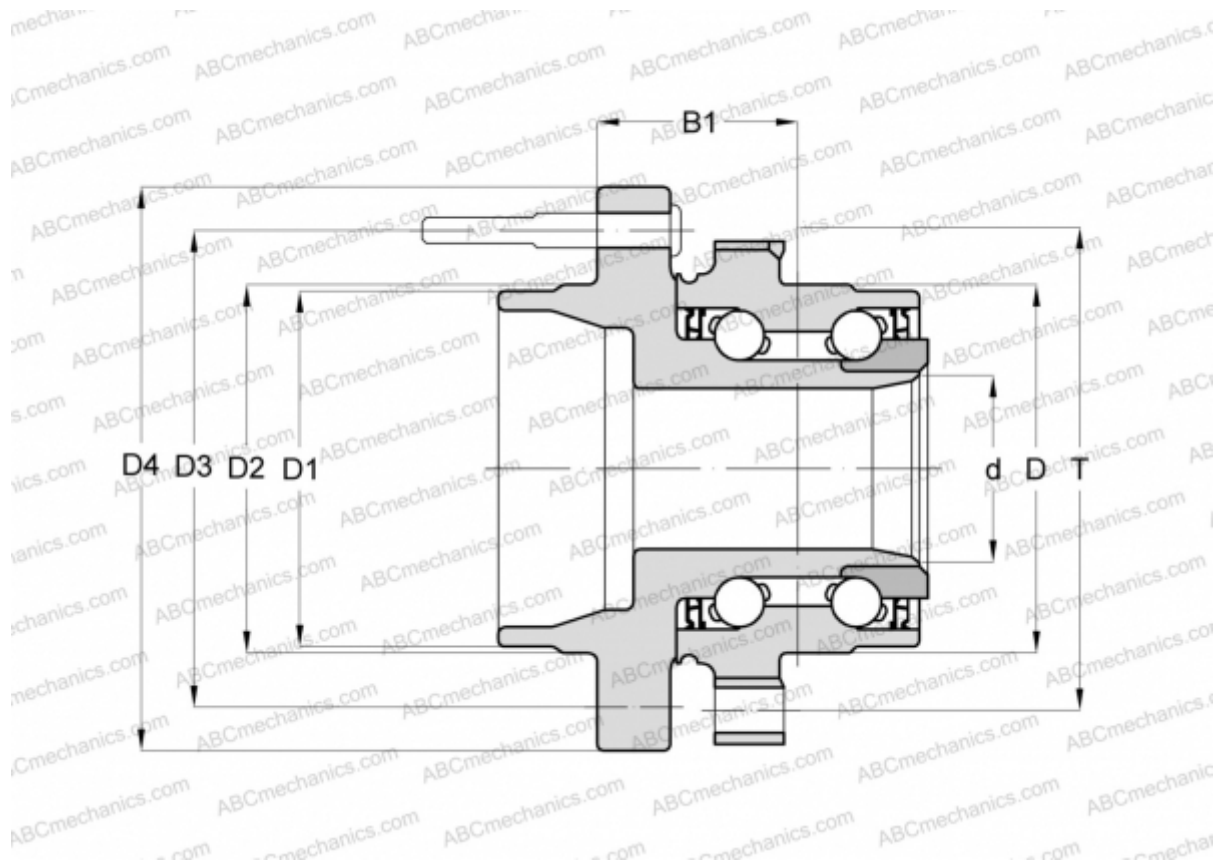

Technical specification

DIMENSIONS, MM

| | |
|----|---------|
| D | 84,000 |
| D1 | 66,000 |
| D2 | 68,000 |
| D3 | 120,000 |
| D4 | 148,000 |
| B1 | 69,000 |
| T | 97,000 |

MANUFACTURER

[FAG](#)