

102367 FAG

Angular contact ball bearings

TYPE: Ball bearings, Angular contact ball bearing, Double row, Hub bearing (unit), FAG production, generation 3

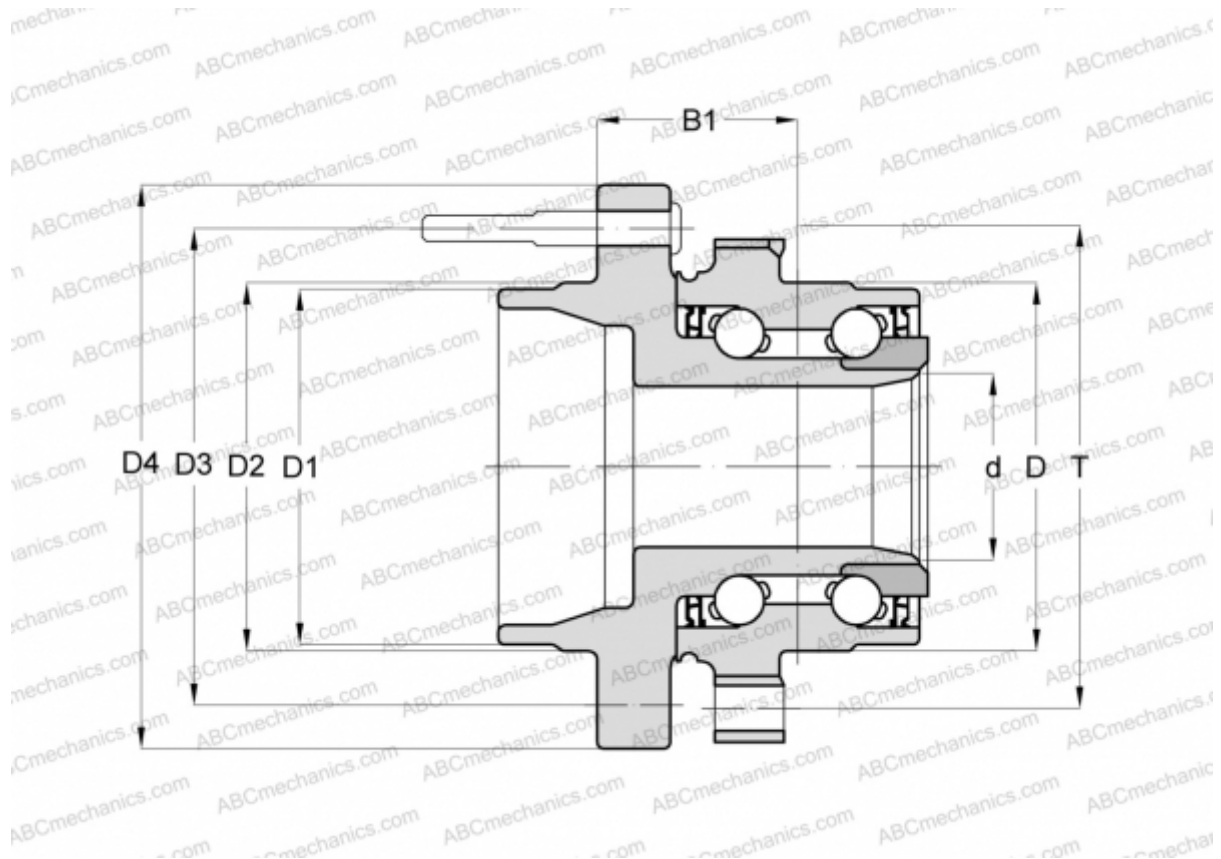

Technical specification

DIMENSIONS, MM

D	78,100
D1	67,000
D2	72,000
D3	114,300
D4	139,700
B1	63,000
T	108,300

MANUFACTURER

[FAG](#)