

## 102377 FAG

Angular contact ball bearings

TYPE: Ball bearings, Angular contact ball bearing, Double row, Hub bearing (unit), FAG production, generation 3

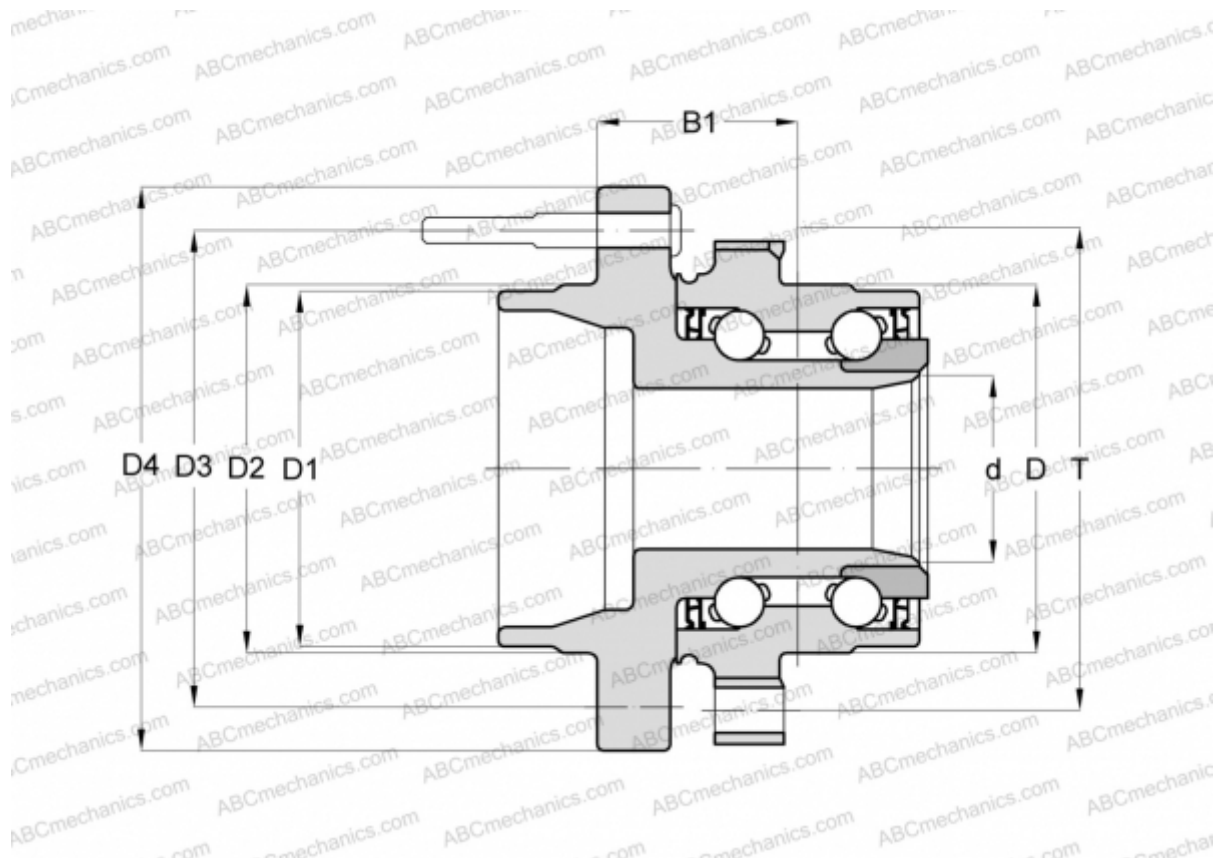

### Technical specification

#### DIMENSIONS, MM

D	82,000
D1	64,000
D2	58,000
D3	114,300
D4	152,000
B1	61,400
T	118,000

#### MANUFACTURER

[FAG](#)