

102447 FAG

Angular contact ball bearings

TYPE: Ball bearings, Angular contact ball bearing, Double row, Hub bearing (unit), FAG production, generation 3

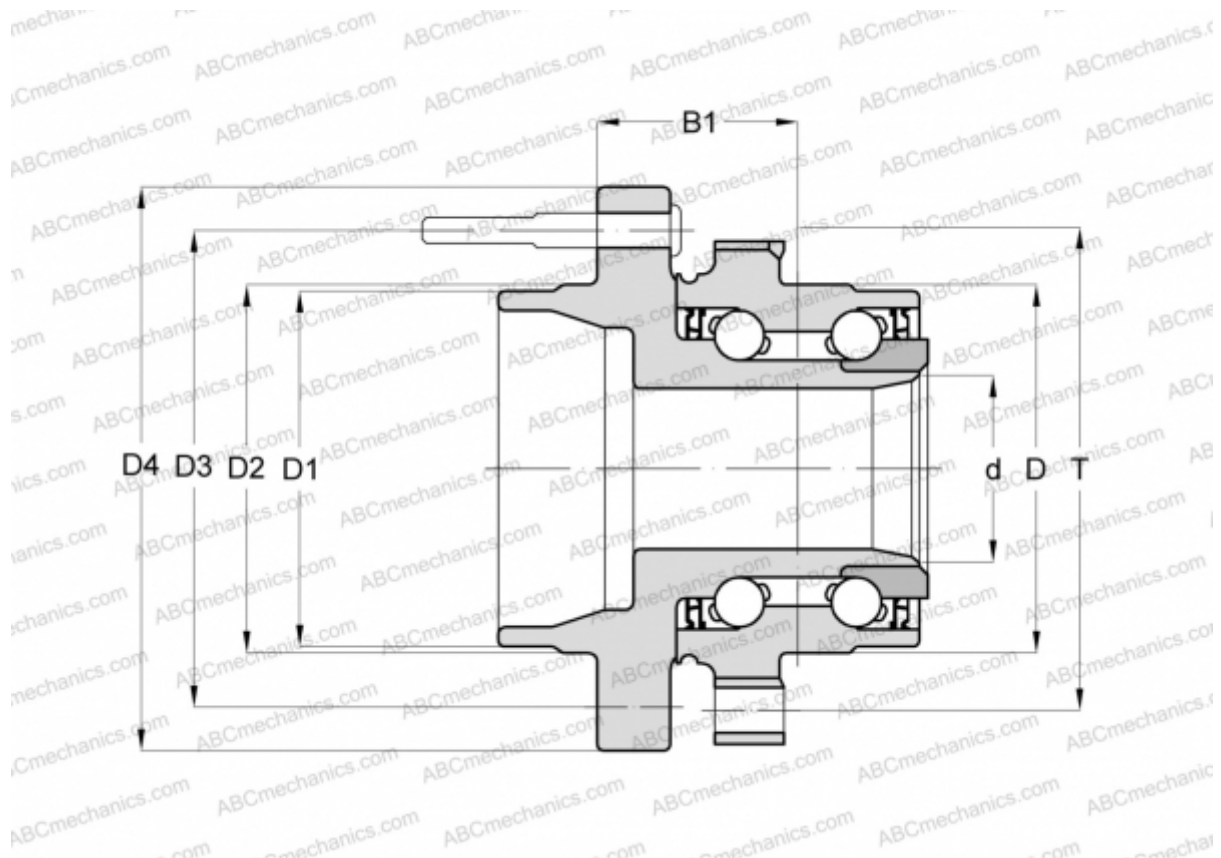

Technical specification

DIMENSIONS, MM

D	140,040
D1	125,000
D2	129,050
D3	140,000
D4	203,000
B1	46,500
T	165,000

MANUFACTURER

[FAG](#)