

102489 FAG

Angular contact ball bearings

TYPE: Ball bearings, Angular contact ball bearing, Double row, Hub bearing (unit), FAG production, generation 3

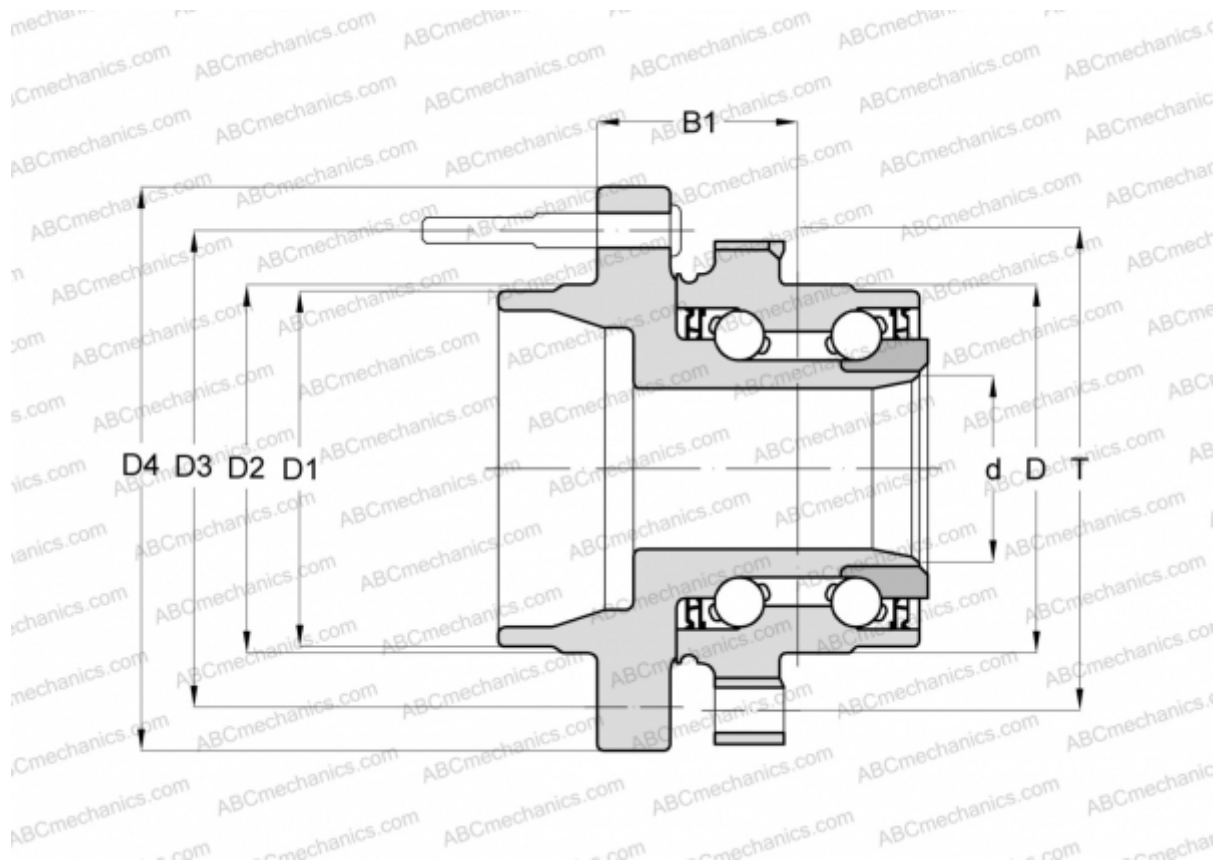

Technical specification

DIMENSIONS, MM

D	86,000
D1	71,370
D2	71,800
D3	114,300
D4	140,000
B1	48,000
T	107,900

MANUFACTURER

[FAG](#)