

## 102503 FAG

Angular contact ball bearings

TYPE: Ball bearings, Angular contact ball bearing, Double row, Hub bearing (unit), FAG production, generation 3

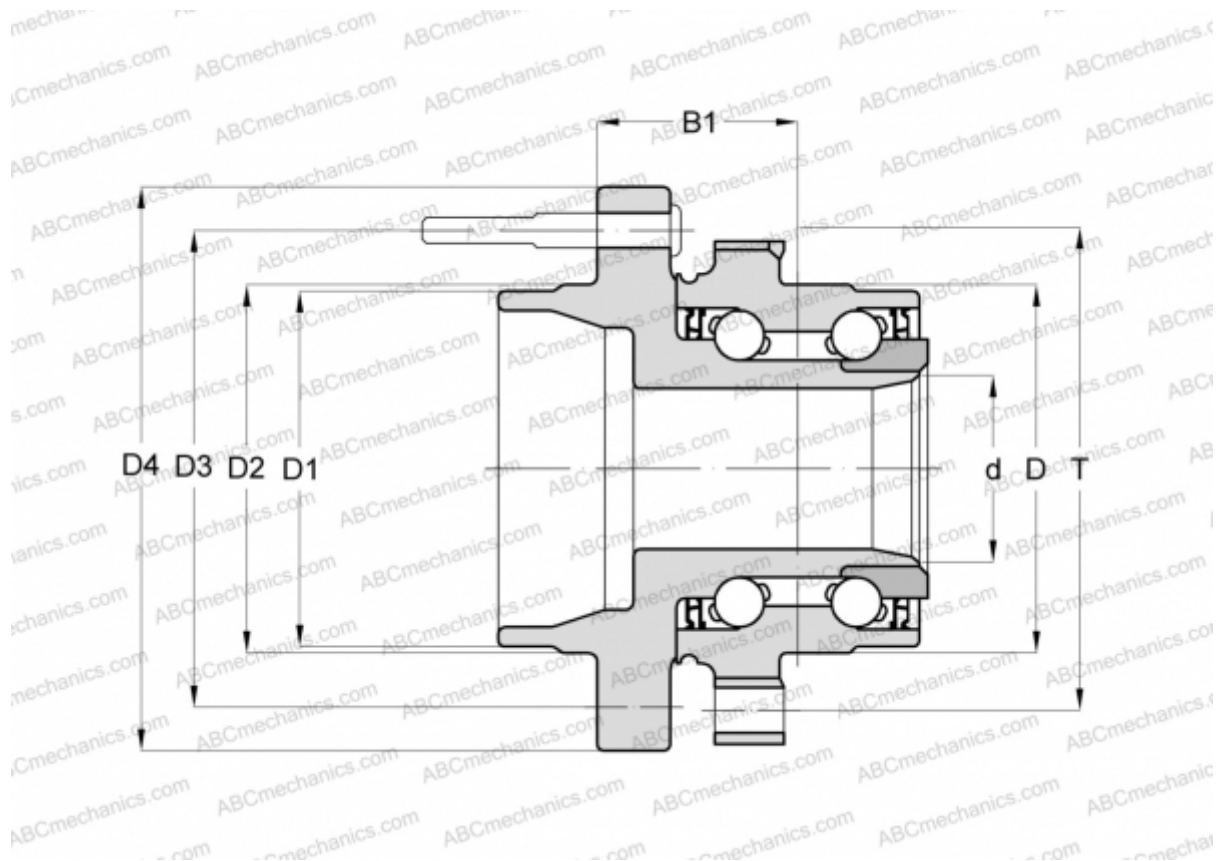

### Technical specification

#### DIMENSIONS, MM

D	73,990
D1	53,975
D2	55,118
D3	99,200
D4	135,000
B1	54,000
T	92,964

#### MANUFACTURER

[FAG](#)