

102504 FAG

Angular contact ball bearings

TYPE: Ball bearings, Angular contact ball bearing, Double row, Hub bearing (unit), FAG production, generation 3

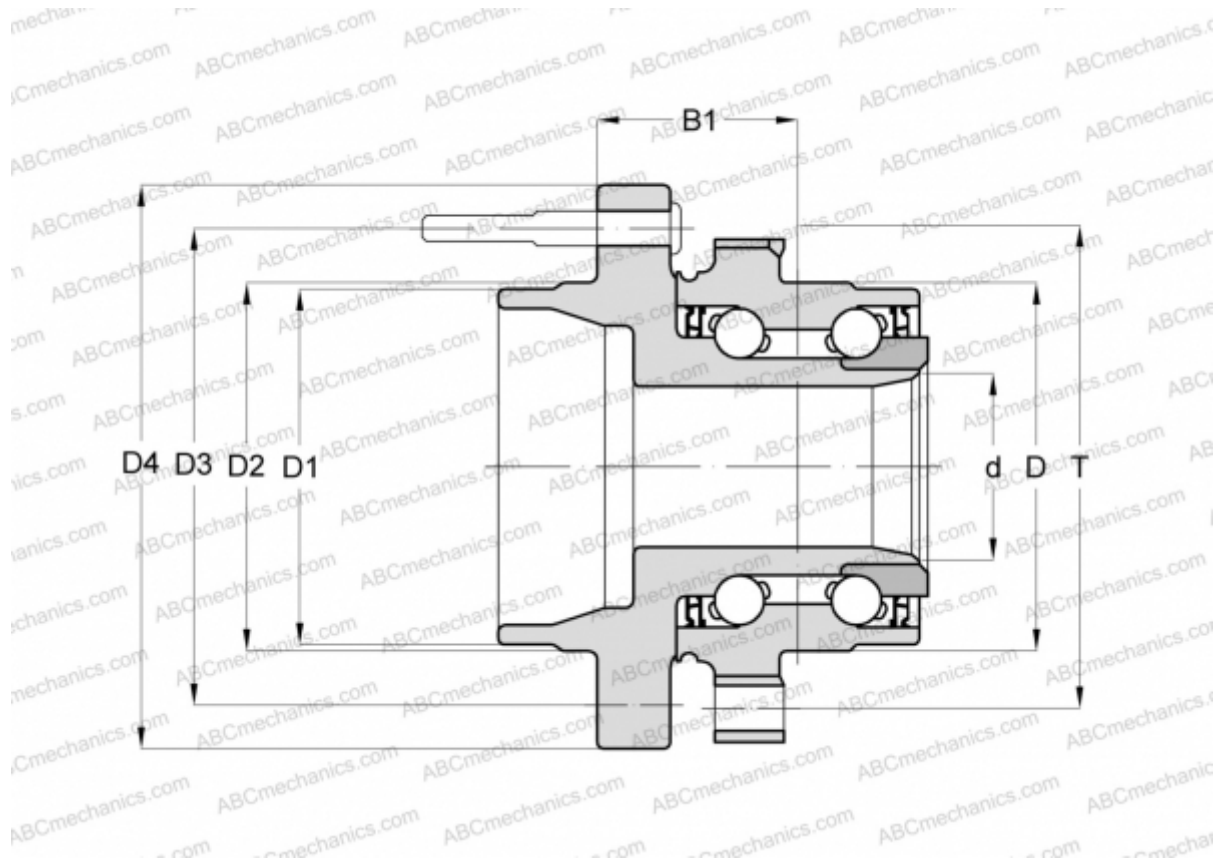

Technical specification

DIMENSIONS, MM

D	73,800
D1	54,000
D2	55,000
D3	100,000
D4	135,000
B1	54,000
T	93,000

MANUFACTURER

[FAG](#)