

CPM 2441 CPM

Angular contact ball bearings

TYPE: Ball bearings, Angular contact ball bearing, Double row, Special, CPM production, series B

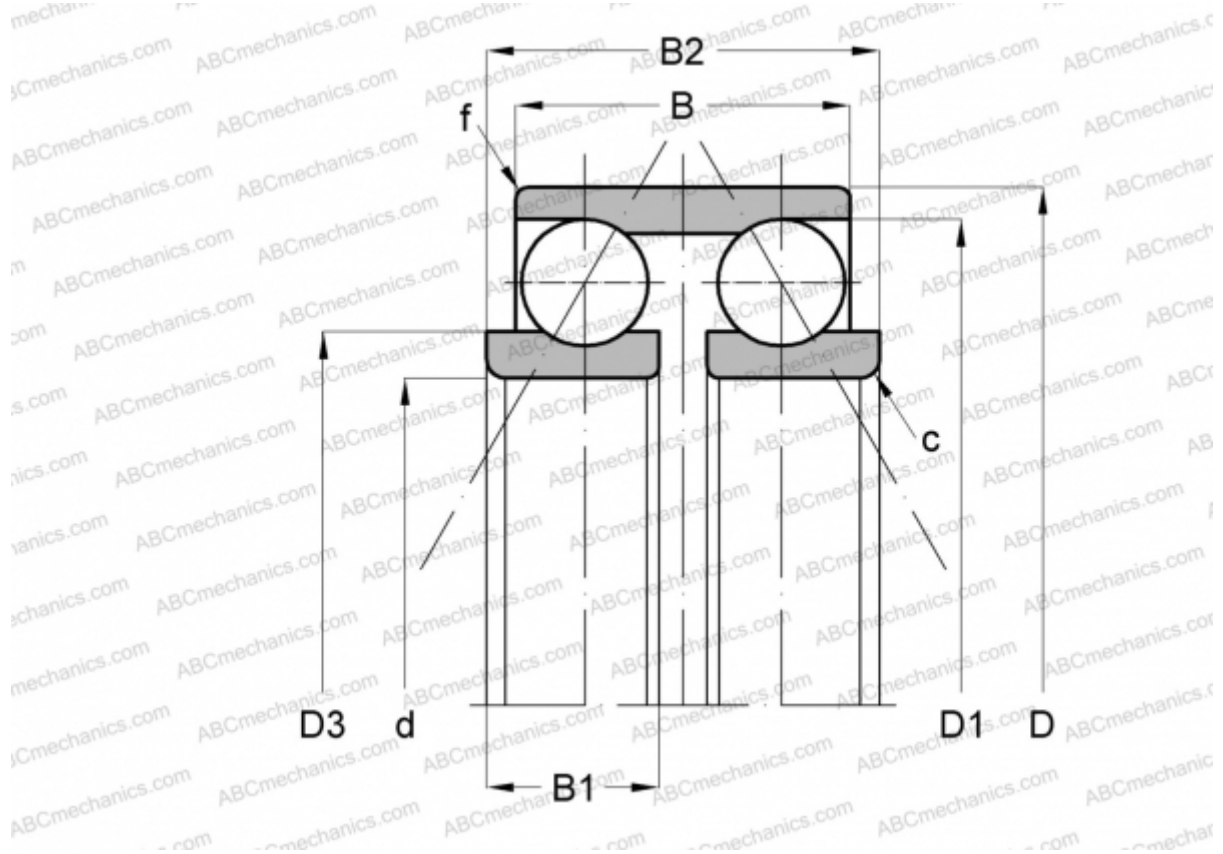

Technical specification

DIMENSIONS, MM

d	230,000
D	312,000
D1	300,700
D3	260,000
B	51,000
B1	32,000
B2	85,000
f	1,100
c	2,500
α	30,000

MANUFACTURER

[CPM](#)