

CPM 2571 CPM

Angular contact ball bearings

TYPE: Ball bearings, Angular contact ball bearing, Double row, Special, CPM production, series B

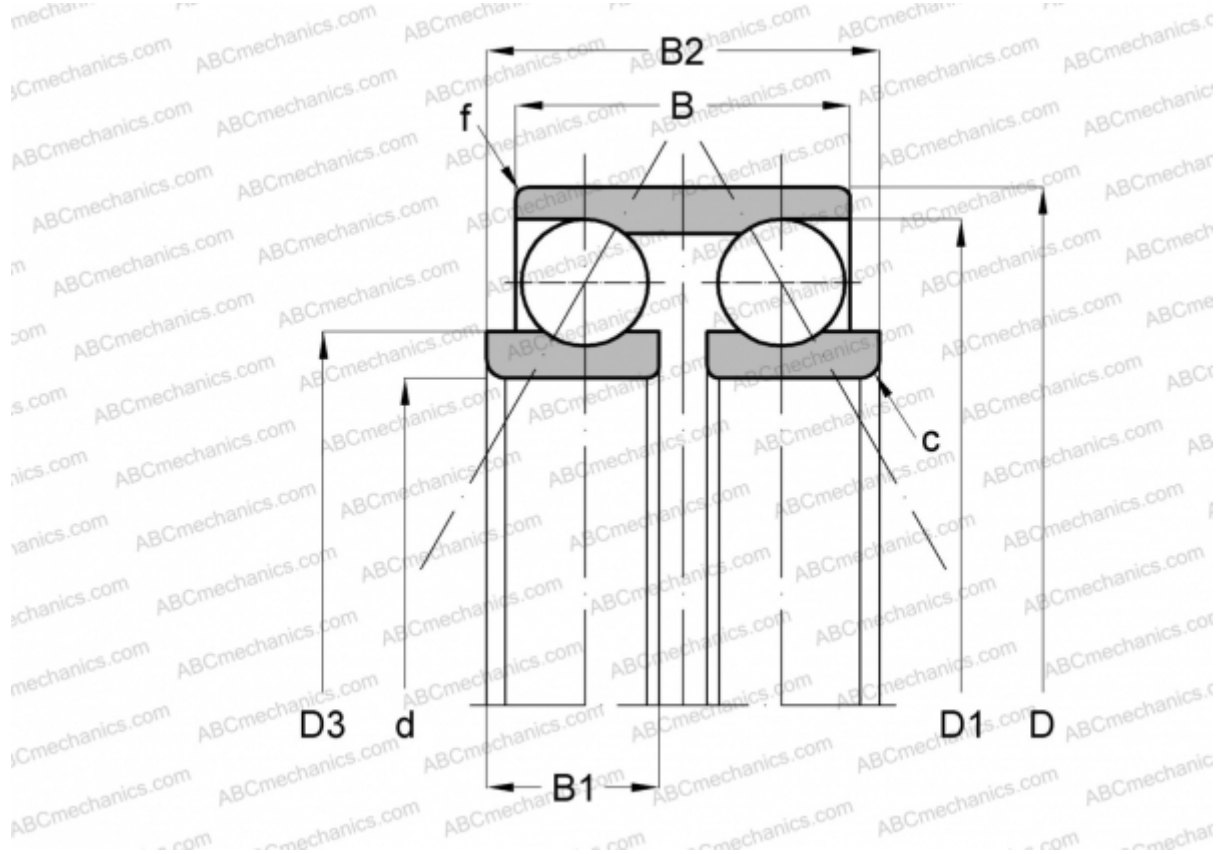

Technical specification

DIMENSIONS, MM

d	320,000
D	420,000
D1	396,400
D3	360,000
B	80,000
B1	35,000
B2	105,000
f	1,000
c	2,500
α	35,000

MANUFACTURER

[CPM](#)