

CPM 2075 CPM

Angular contact ball bearings

TYPE: Ball bearings, Angular contact ball bearing, Double row, Special, CPM production, series C

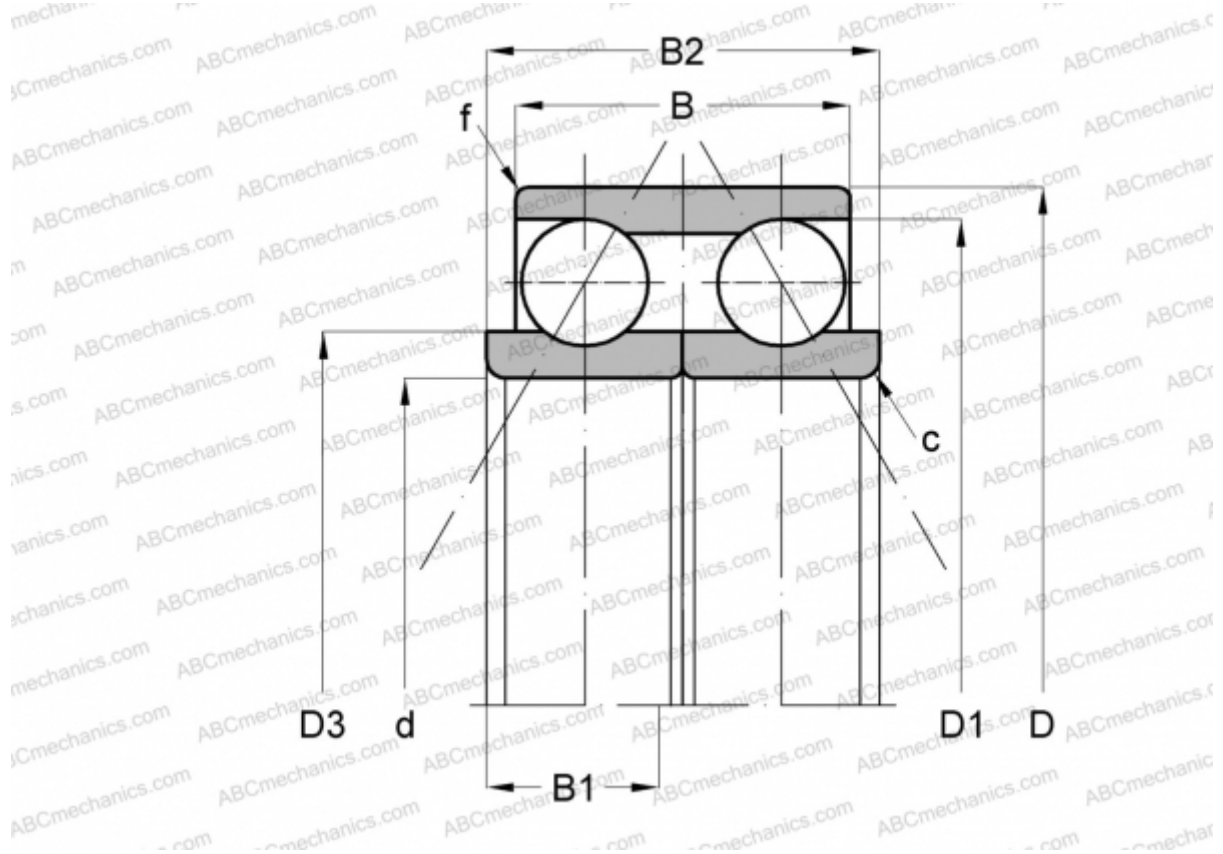

Technical specification

DIMENSIONS, MM

d	96,000
D	152,400
D1	132,800
D3	120,200
B	45,000
B1	23,000
B2	46,000
f	1,500
c	1,500
α	35,000

MANUFACTURER

[CPM](#)