

CPM 2517 CPM

Angular contact ball bearings

TYPE: Ball bearings, Angular contact ball bearing, Double row, Special, CPM production, series C

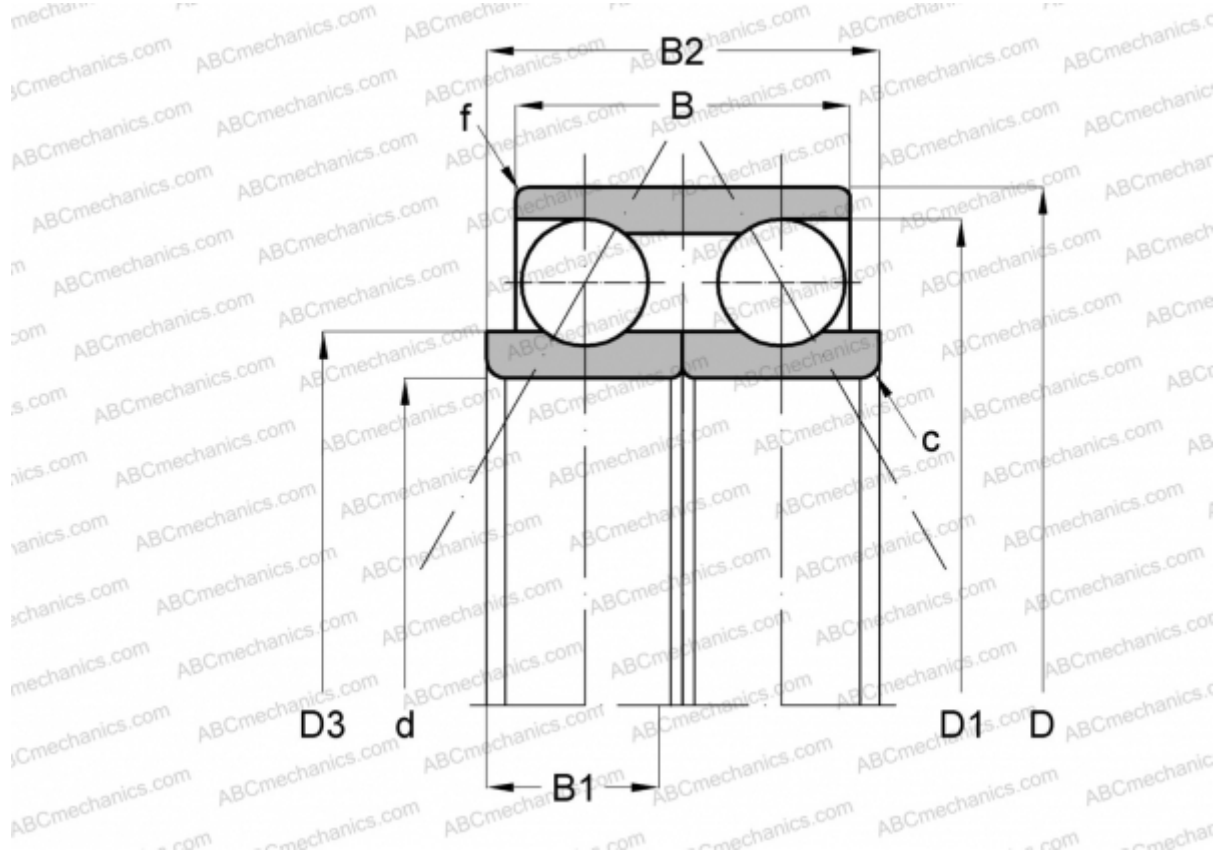

Technical specification

DIMENSIONS, MM

d	200,000
D	255,000
D1	237,500
D3	224,500
B	32,000
B1	16,000
B2	32,000
f	2,500
c	2,000
α	35,000

MANUFACTURER

[CPM](#)