

CPM 2784 CPM

Angular contact ball bearings

TYPE: Ball bearings, Angular contact ball bearing, Double row, Special, CPM production, series D

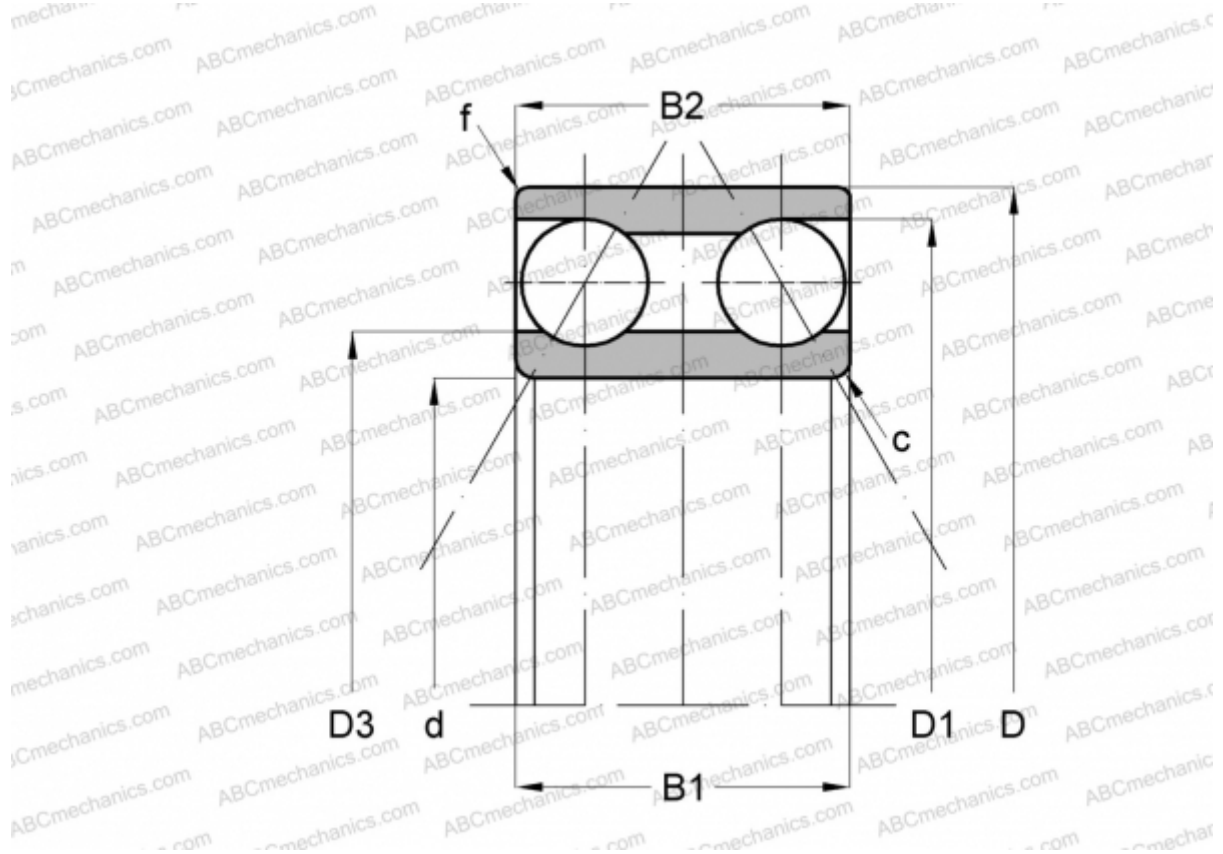

Technical specification

DIMENSIONS, MM

d	304,800
D	342,900
D1	327,850
D3	319,900
B	19,050
B1	19,050
f	2,000
c	2,000
α	15,000

MANUFACTURER

[CPM](#)