

F8-16M ABC

Thrust ball bearings

TYPE: Ball bearings, Thrust ball bearing, Single direction, Separable, miniature

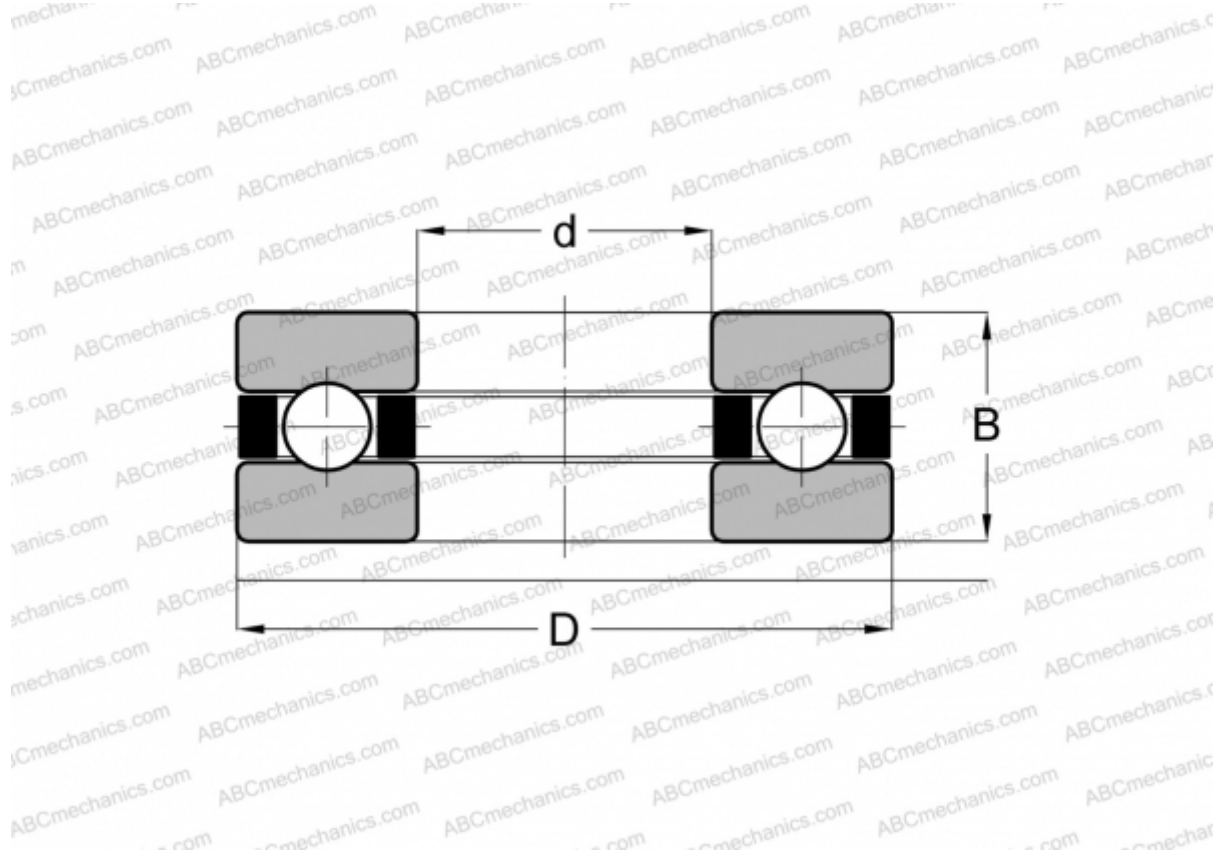

Technical specification

DIMENSIONS, MM

d	8,000
D	16,000
B	5,000

WEIGHT, KG 0,004

MANUFACTURER [ABC](#)

INTERCHANGE

NACHI [8TAM16](#)