

B9 ADR

Thrust ball bearings

TYPE: Ball bearings, Thrust ball bearing, Single direction, Separable, miniature

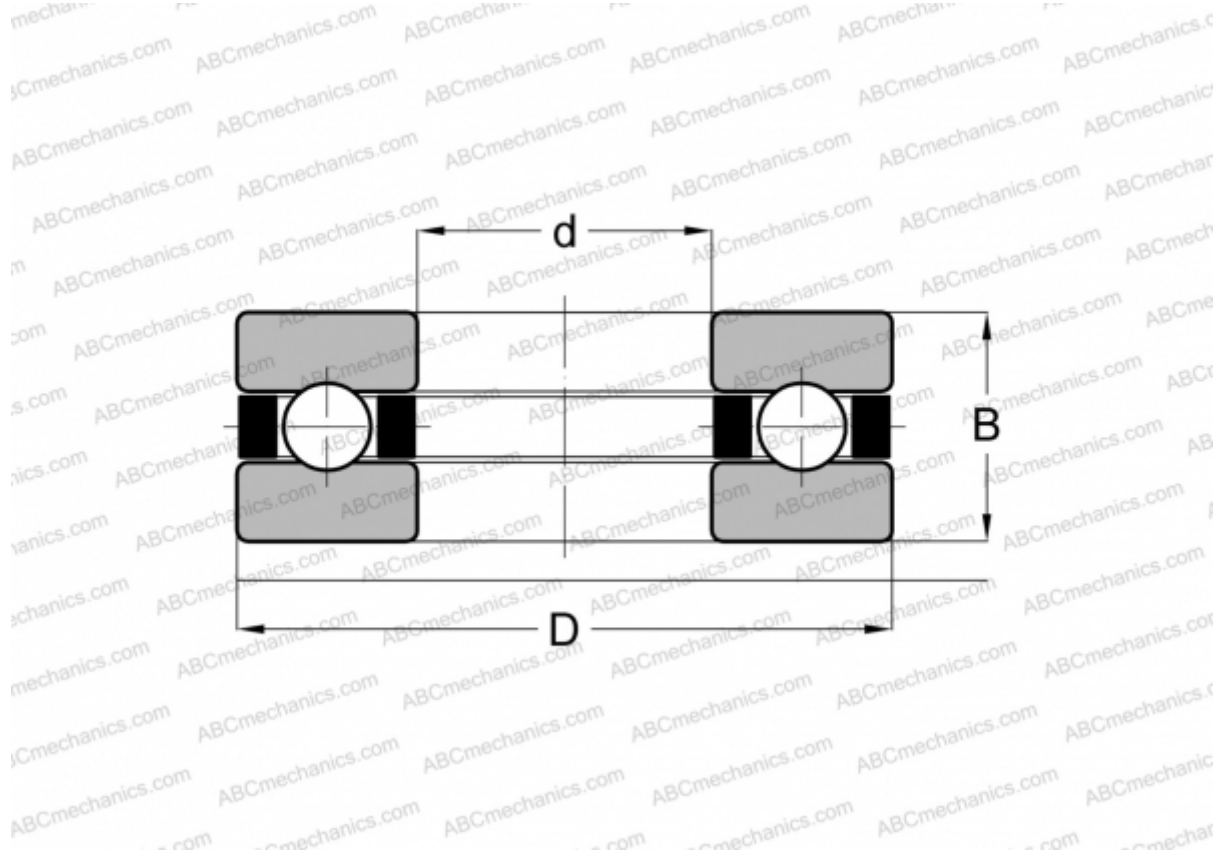

Technical specification

DIMENSIONS, MM

d	9,000
D	20,000
B	7,000

WEIGHT, KG 0,010

MANUFACTURER [ADR](#)

INTERCHANGE

ABC	F9-20M
RMB	B920