

2905 MRC

Thrust ball bearings

TYPE: Ball bearings, Thrust ball bearing, Single direction, Separable, series 9/10/29/39

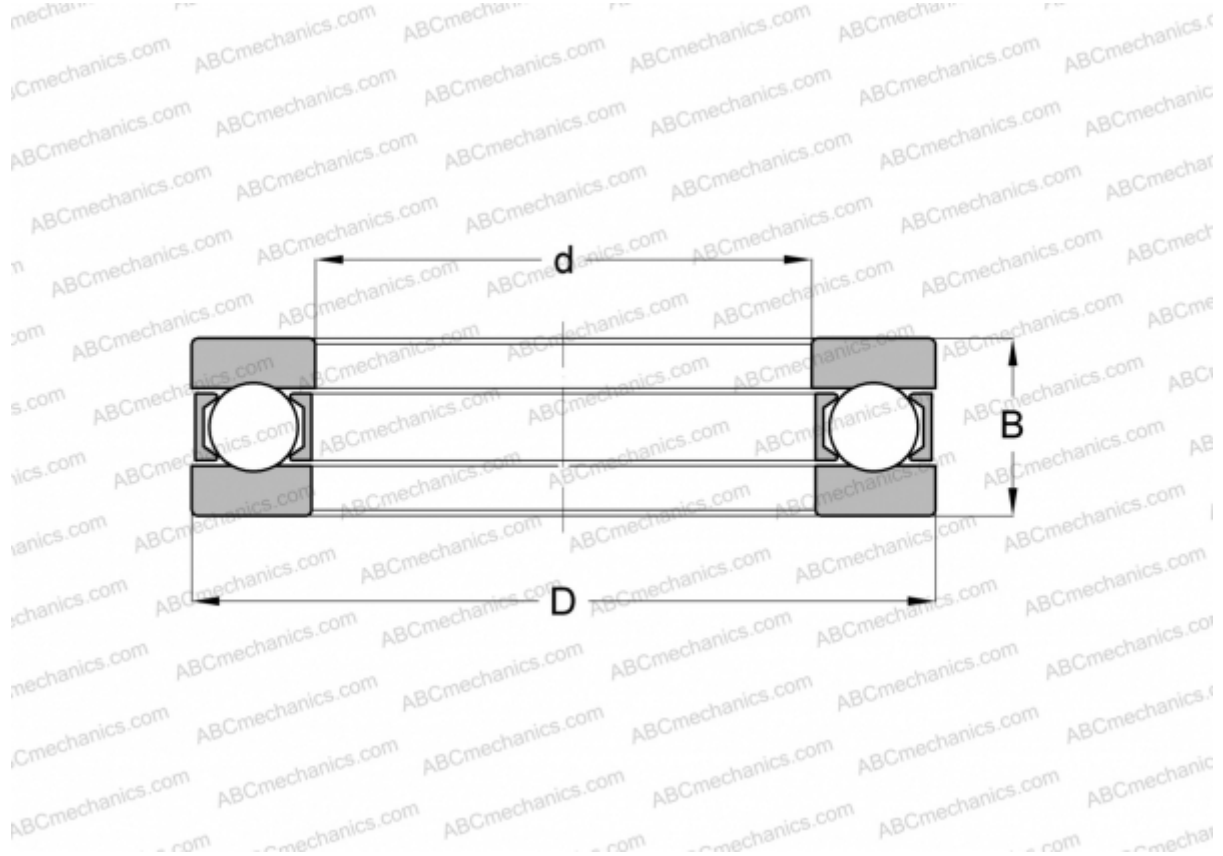

Technical specification

DIMENSIONS, MM

d	25,000
D	45,000
D1	25,200
D2	45,000
B	14,000

WEIGHT, KG 0,100

MANUFACTURER [MRC](#)

INTERCHANGE

INA	2905
HOFFMANN	XLM 25
SKF	2905