

2906 INA

Thrust ball bearings

TYPE: Ball bearings, Thrust ball bearing, Single direction, Separable, series 9/10/29/39

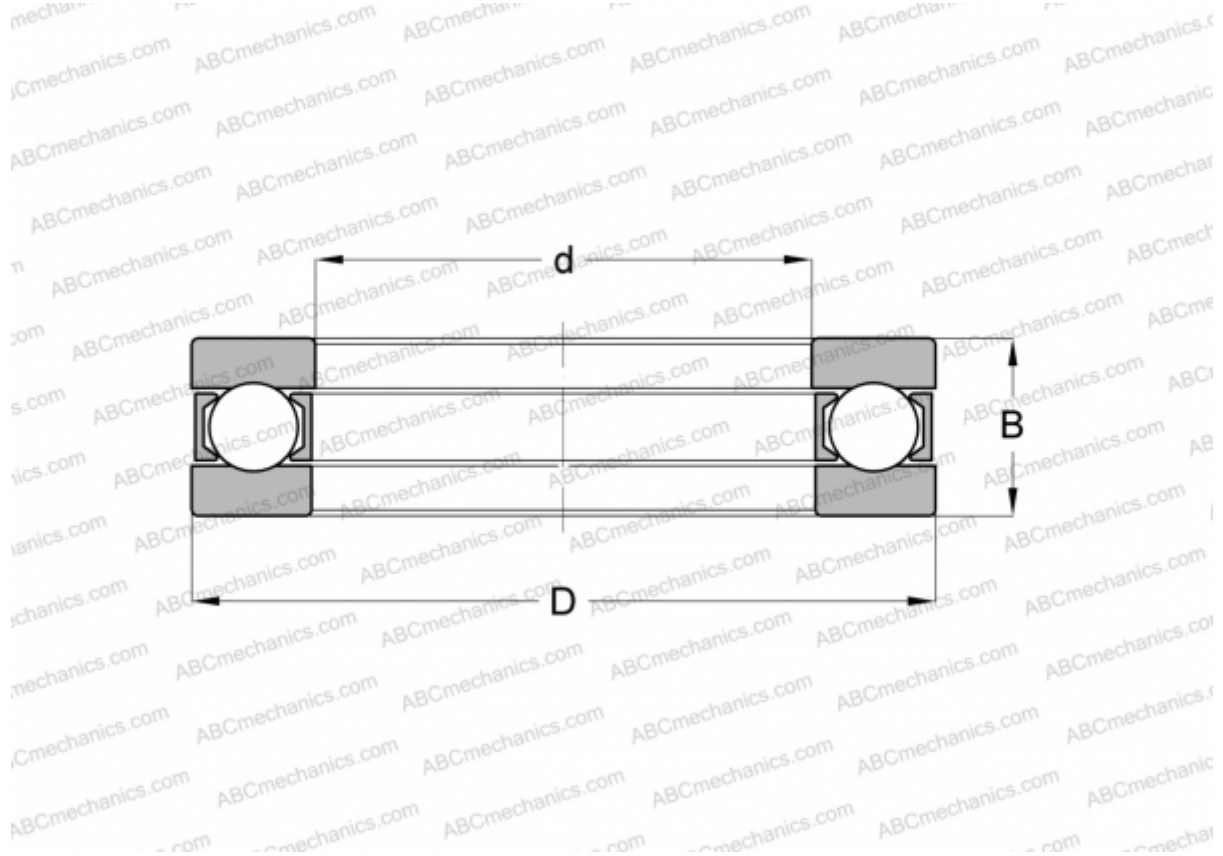

Technical specification

DIMENSIONS, MM

d	30,000
D	50,000
D1	30,200
D2	50,000
B	14,000

WEIGHT, KG 0,113

MANUFACTURER [INA](#)

INTERCHANGE

MRC	2906
HOFFMANN	XLM 30
SKF	2906