

2907 MRC

Thrust ball bearings

TYPE: Ball bearings, Thrust ball bearing, Single direction, Separable, series 9/10/29/39

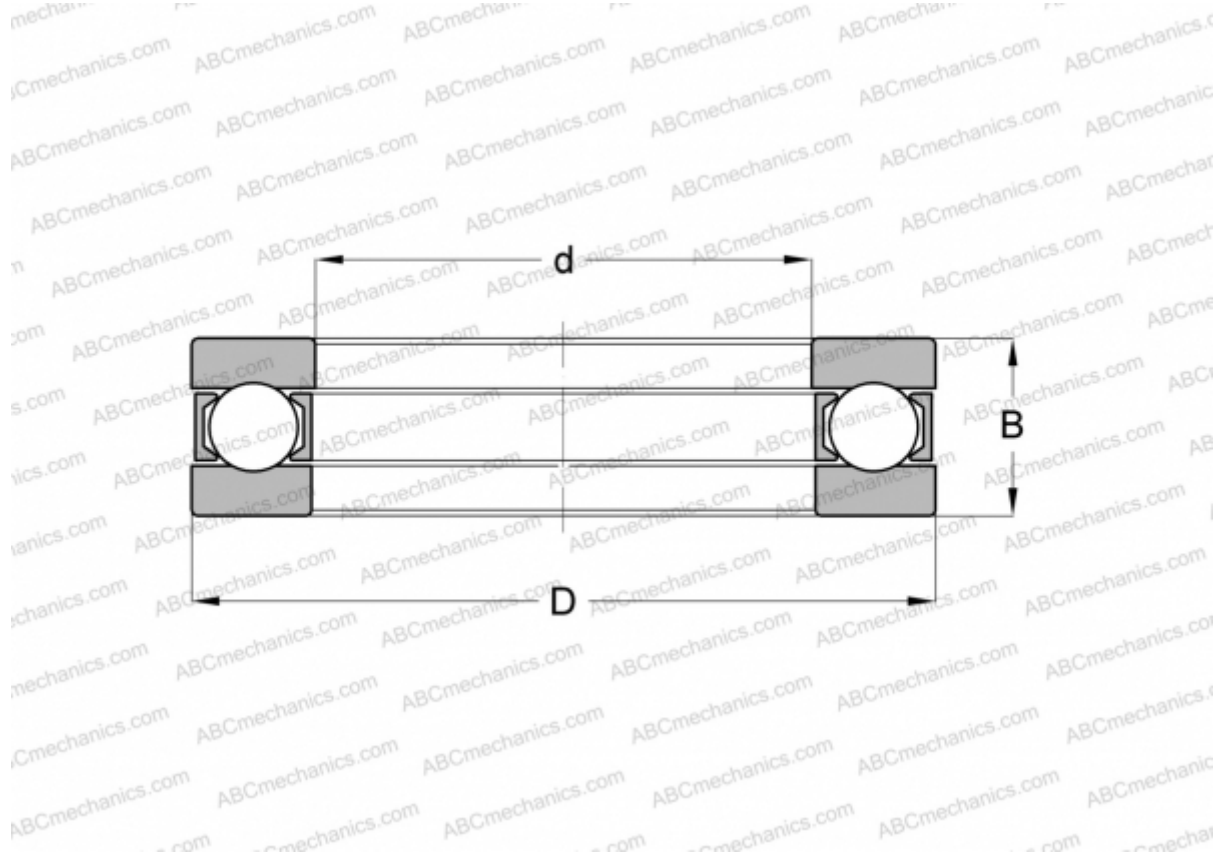

Technical specification

DIMENSIONS, MM

d	35,000
D	55,000
D1	35,200
D2	55,000
B	16,000

WEIGHT, KG 0,145

MANUFACTURER [MRC](#)

INTERCHANGE

INA	2907
HOFFMANN	XLM 35
SKF	2907