

2908 MRC

Thrust ball bearings

TYPE: Ball bearings, Thrust ball bearing, Single direction, Separable, series 9/10/29/39

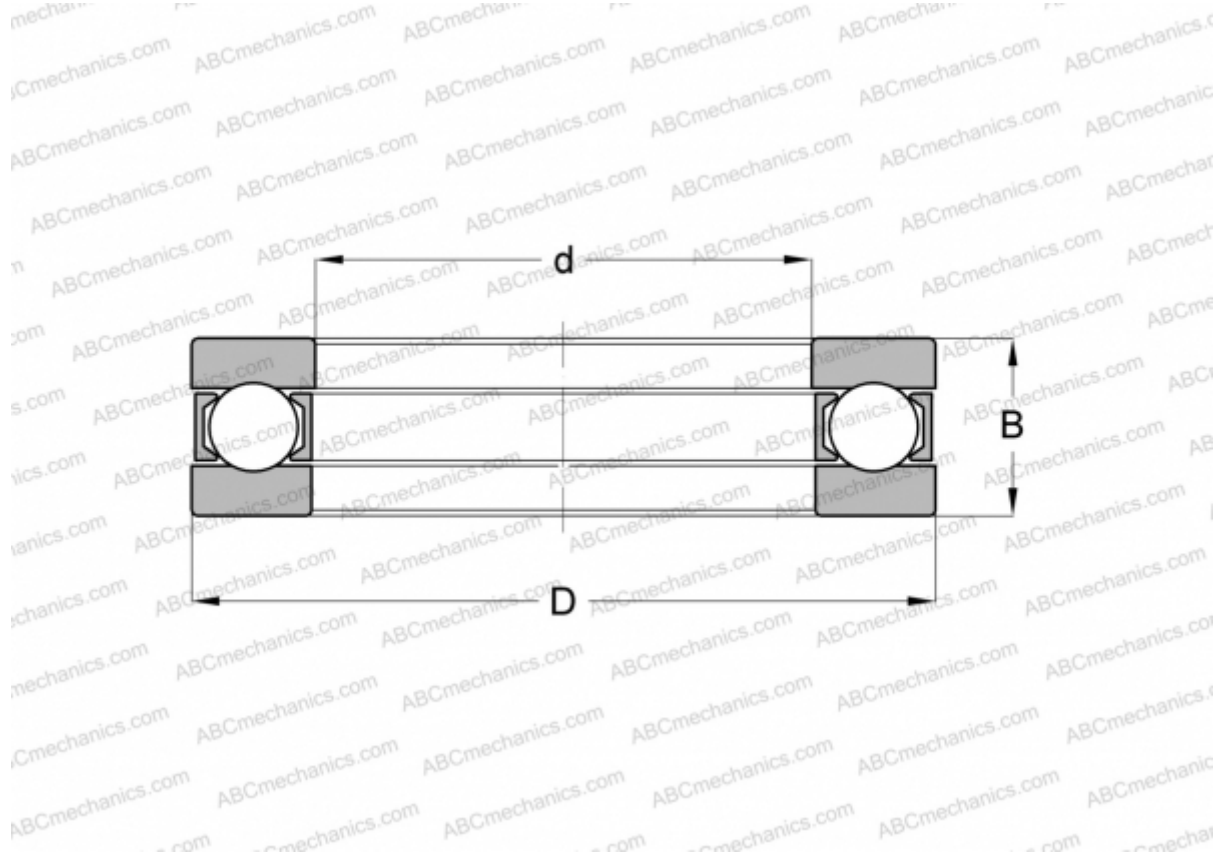

Technical specification

DIMENSIONS, MM

d	40,000
D	60,000
D1	40,200
D2	60,000
B	16,000

WEIGHT, KG 0,159

MANUFACTURER [MRC](#)

INTERCHANGE

INA	2908
HOFFMANN	XLM 40
SKF	2908