

2909 SKF

Thrust ball bearings

TYPE: Ball bearings, Thrust ball bearing, Single direction, Separable, series 9/10/29/39

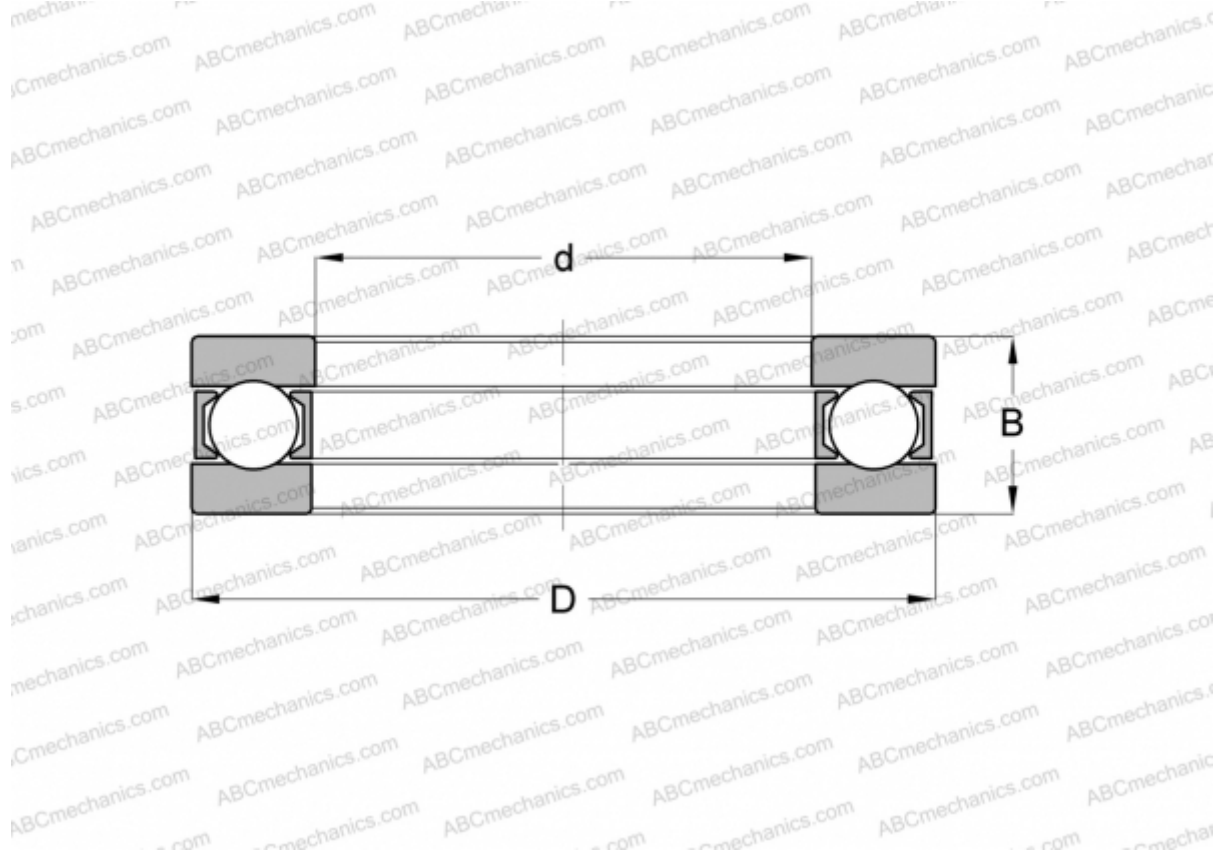

Technical specification

DIMENSIONS, MM

d	45,000
D	68,000
D1	45,200
D2	68,000
B	16,000

WEIGHT, KG 0,222

MANUFACTURER [SKF](#)

INTERCHANGE

INA	2909
MRC	2909
HOFFMANN	XLM 45