

2910 INA

Thrust ball bearings

TYPE: Ball bearings, Thrust ball bearing, Single direction, Separable, series 9/10/29/39

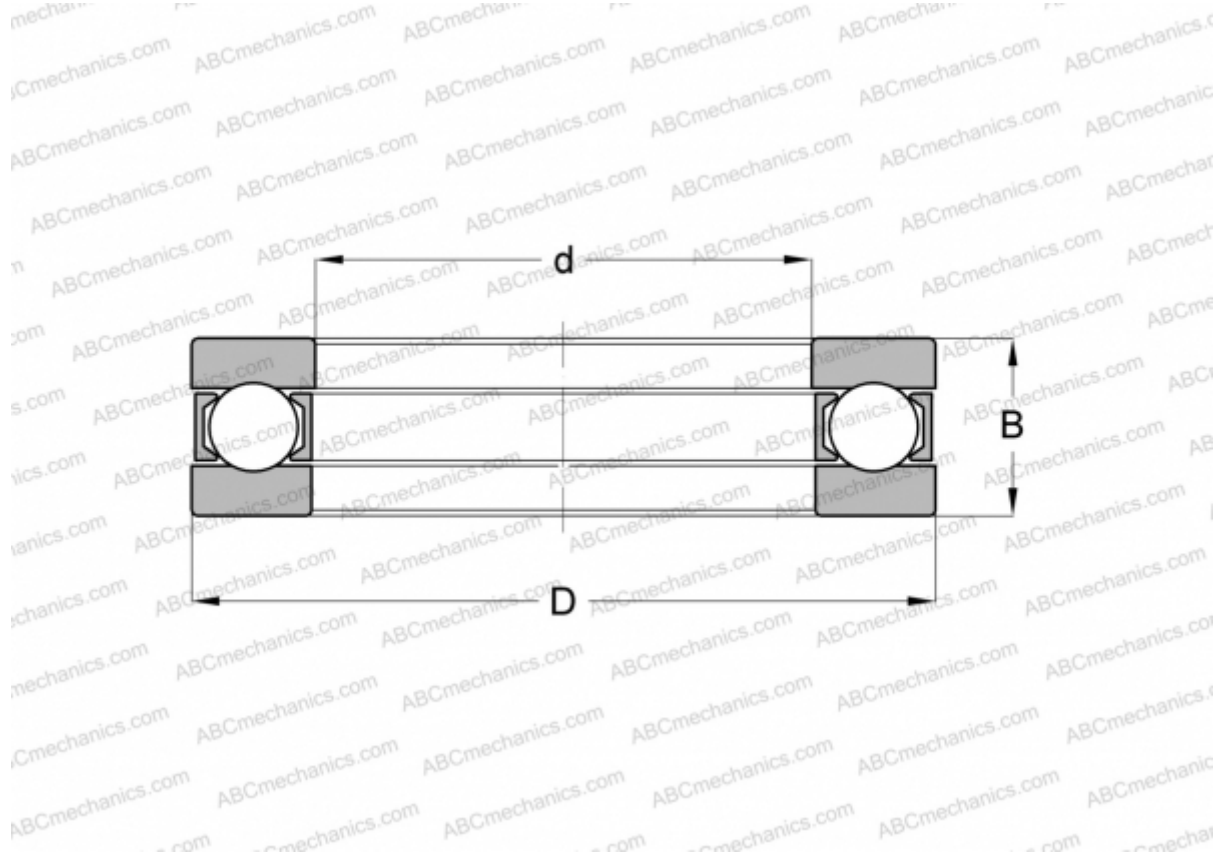

Technical specification

DIMENSIONS, MM

d	50,000
D	74,000
D1	50,200
D2	74,000
B	18,000

WEIGHT, KG 0,259

MANUFACTURER [INA](#)

INTERCHANGE

MRC	2910
SKF	2910