

2912 INA

Thrust ball bearings

TYPE: Ball bearings, Thrust ball bearing, Single direction, Separable, series 9/10/29/39

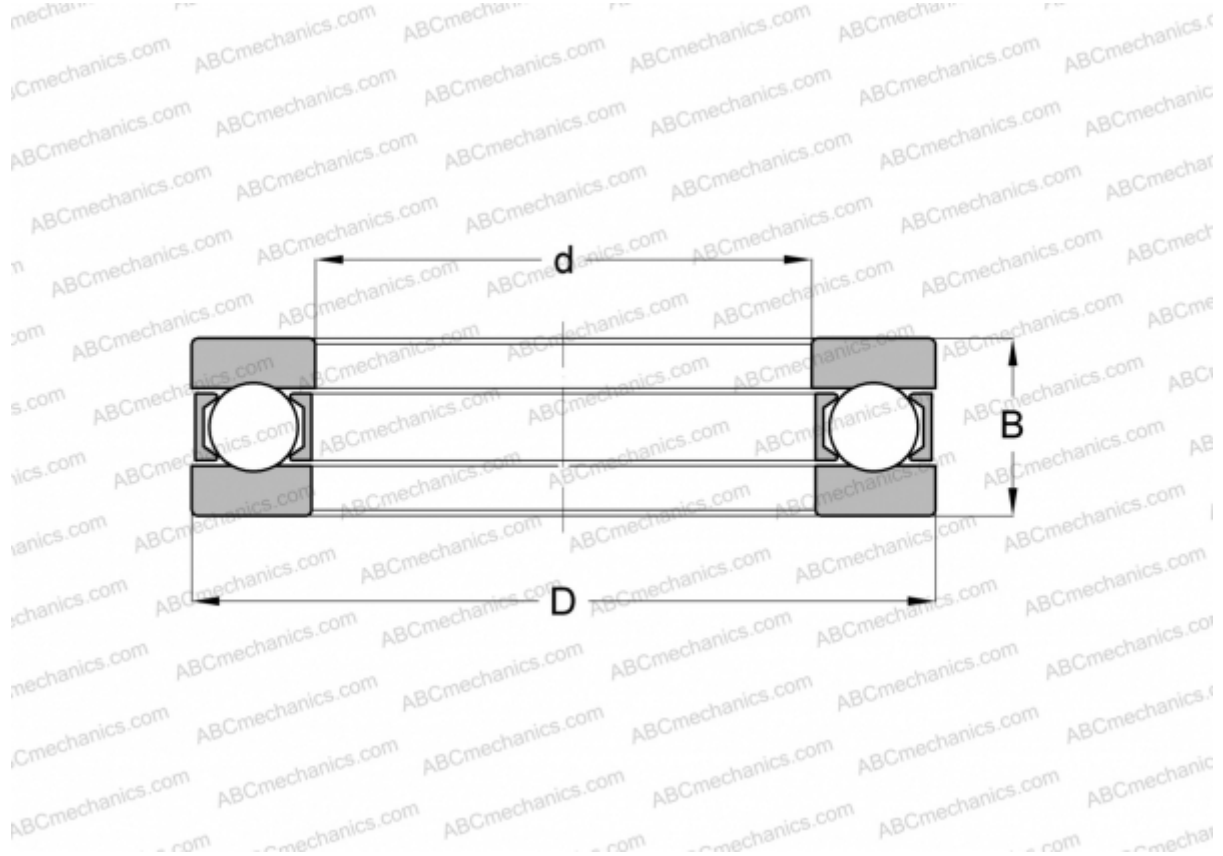

Technical specification

DIMENSIONS, MM

d	60,000
D	82,000
D1	60,200
D2	82,000
B	18,000

WEIGHT, KG 0,295

MANUFACTURER [INA](#)

INTERCHANGE

MRC	2912
SKF	2912