

2914 INA

Thrust ball bearings

TYPE: Ball bearings, Thrust ball bearing, Single direction, Separable, series 9/10/29/39

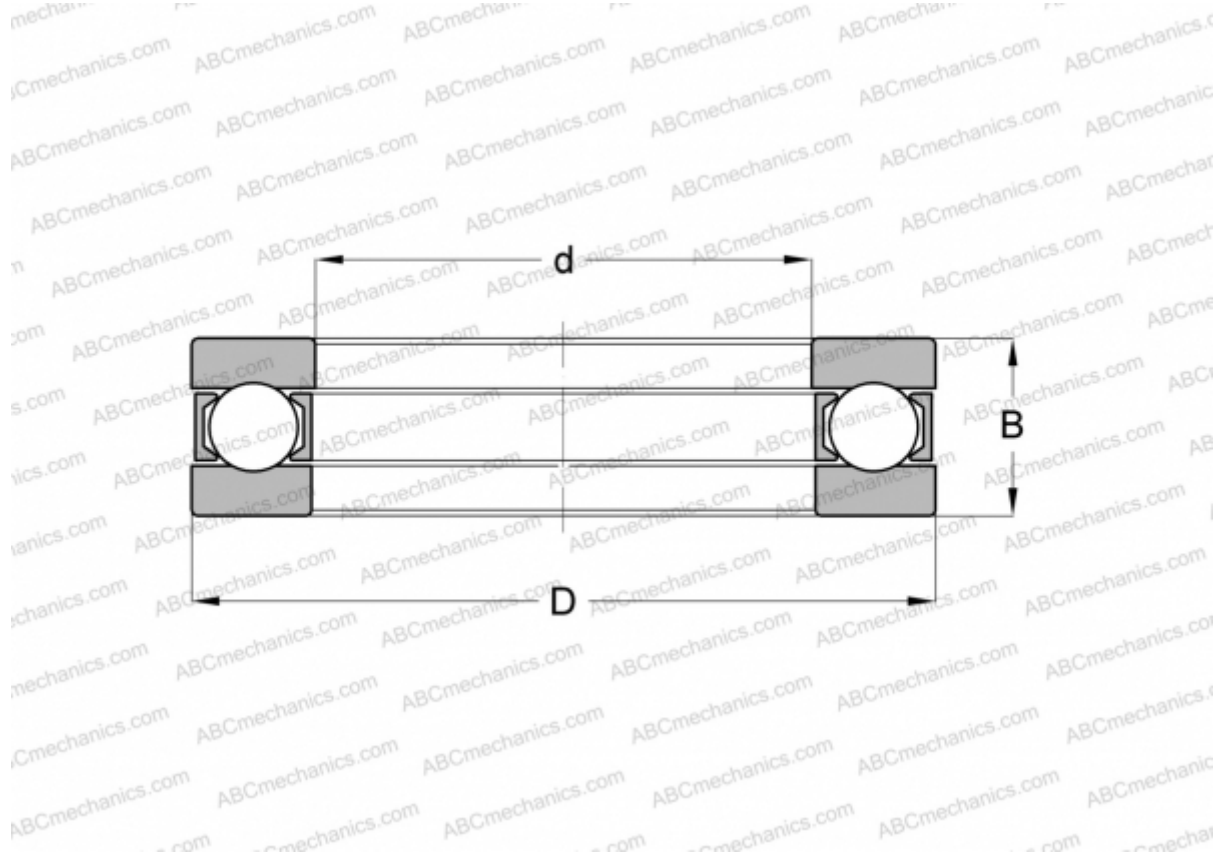

Technical specification

DIMENSIONS, MM

d	70,000
D	95,000
D1	70,200
D2	95,000
B	20,000

WEIGHT, KG 0,399

MANUFACTURER [INA](#)

INTERCHANGE

MRC	2914
SKF	2914