

2915 MRC

Thrust ball bearings

TYPE: Ball bearings, Thrust ball bearing, Single direction, Separable, series 9/10/29/39

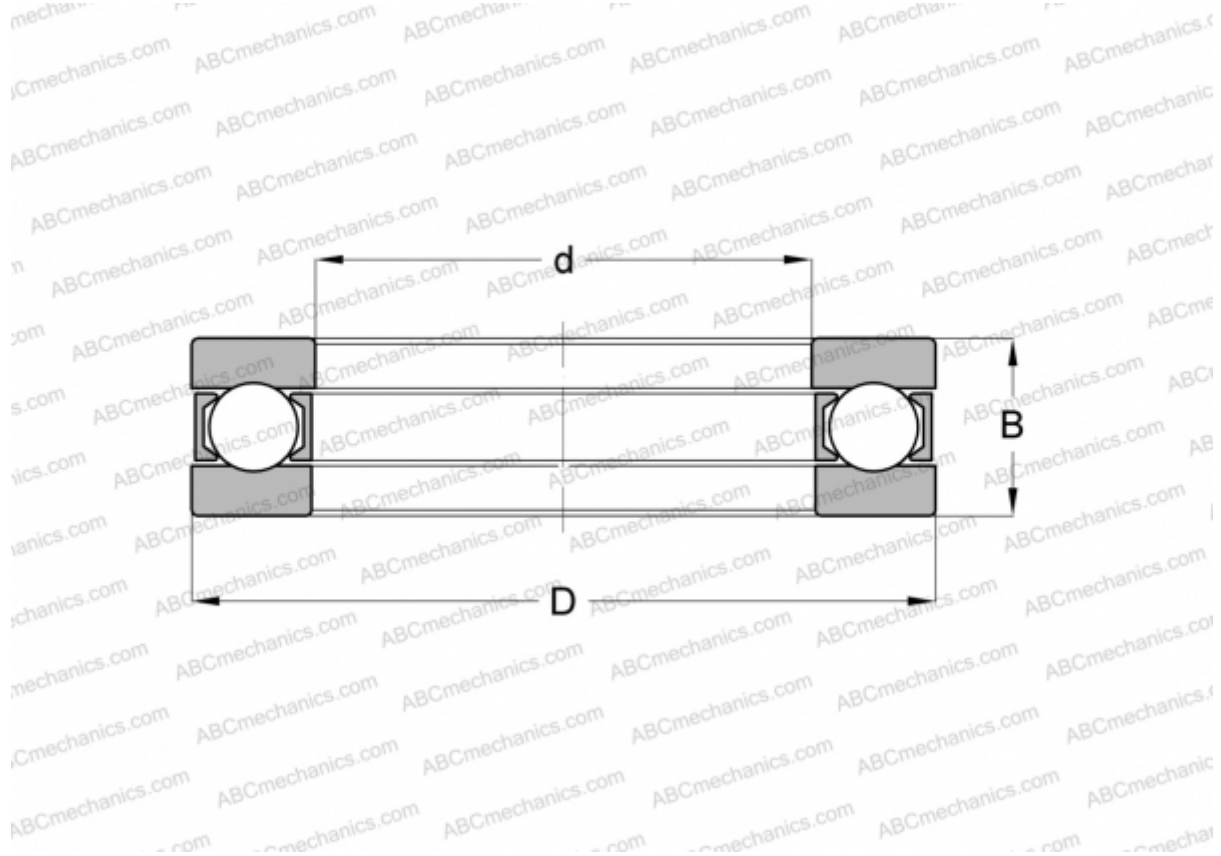

Technical specification

DIMENSIONS, MM

d	75,000
D	100,000
D1	75,200
D2	100,000
B	20,000

WEIGHT, KG 0,426

MANUFACTURER [MRC](#)

INTERCHANGE

INA	2915
SKF	2915