

2916 INA

Thrust ball bearings

TYPE: Ball bearings, Thrust ball bearing, Single direction, Separable, series 9/10/29/39

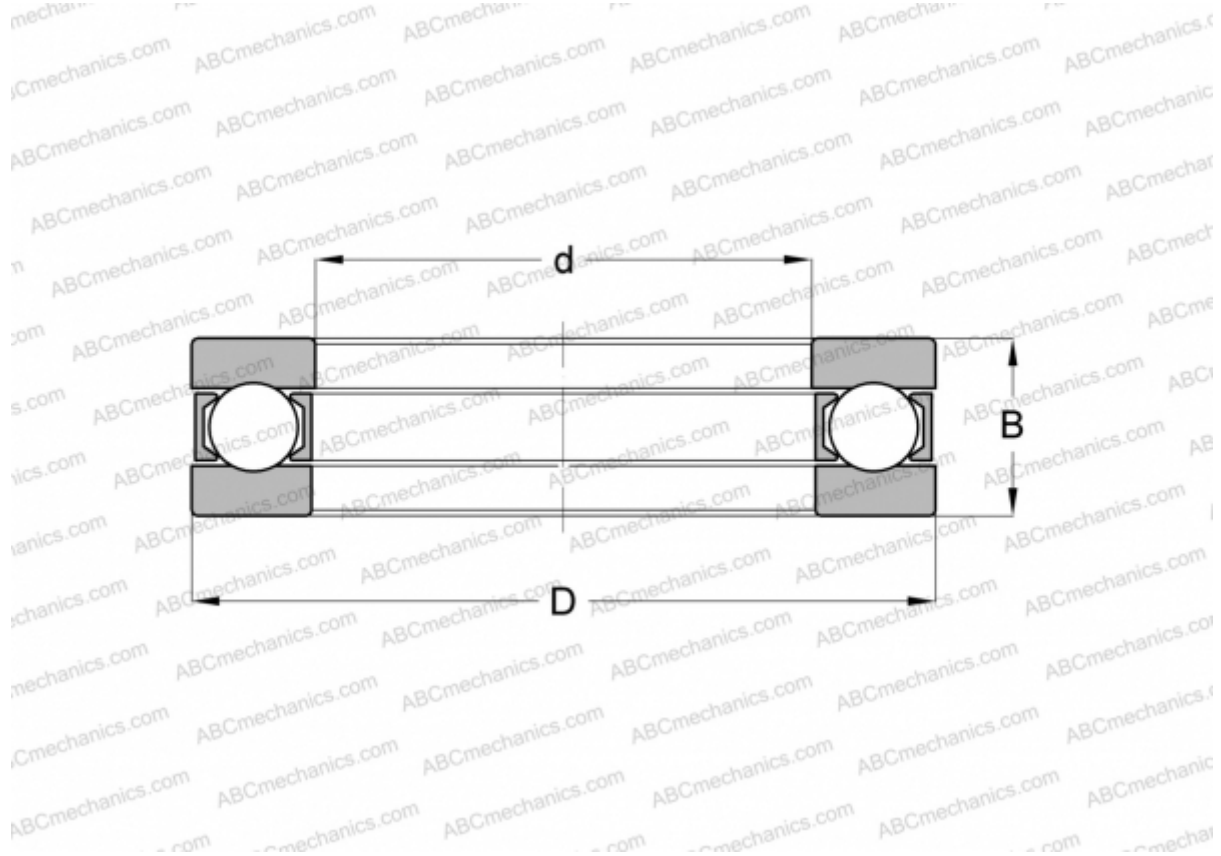

Technical specification

DIMENSIONS, MM

d	80,000
D	110,000
D1	80,200
D2	110,000
B	22,000

WEIGHT, KG 0,572

MANUFACTURER [INA](#)

INTERCHANGE

MRC	2916
SKF	2916