

2917 INA

Thrust ball bearings

TYPE: Ball bearings, Thrust ball bearing, Single direction, Separable, series 9/10/29/39

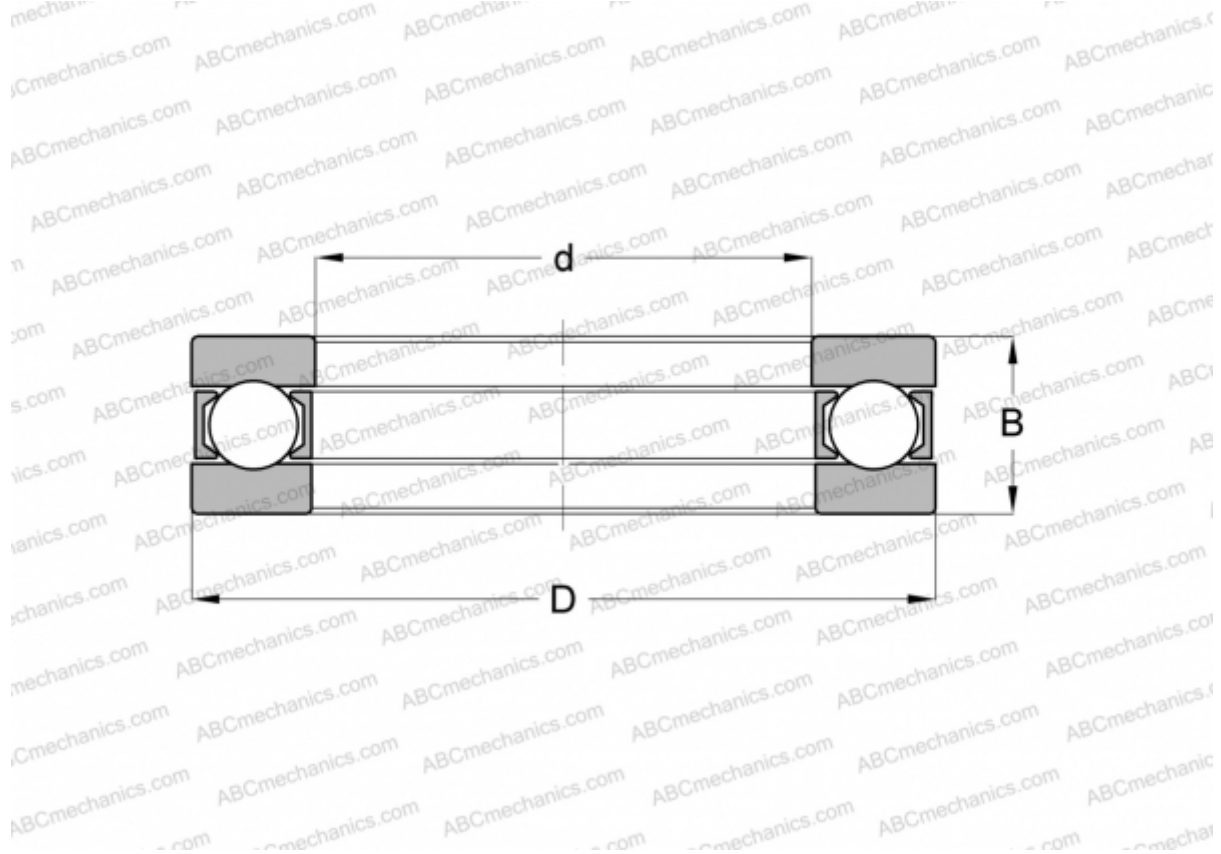

Technical specification

DIMENSIONS, MM

d	85,000
D	115,000
D1	85,200
D2	115,000
B	22,000

WEIGHT, KG 0,703

MANUFACTURER [INA](#)

INTERCHANGE

MRC	2917
SKF	2917