

2918 INA

Thrust ball bearings

TYPE: Ball bearings, Thrust ball bearing, Single direction, Separable, series 9/10/29/39

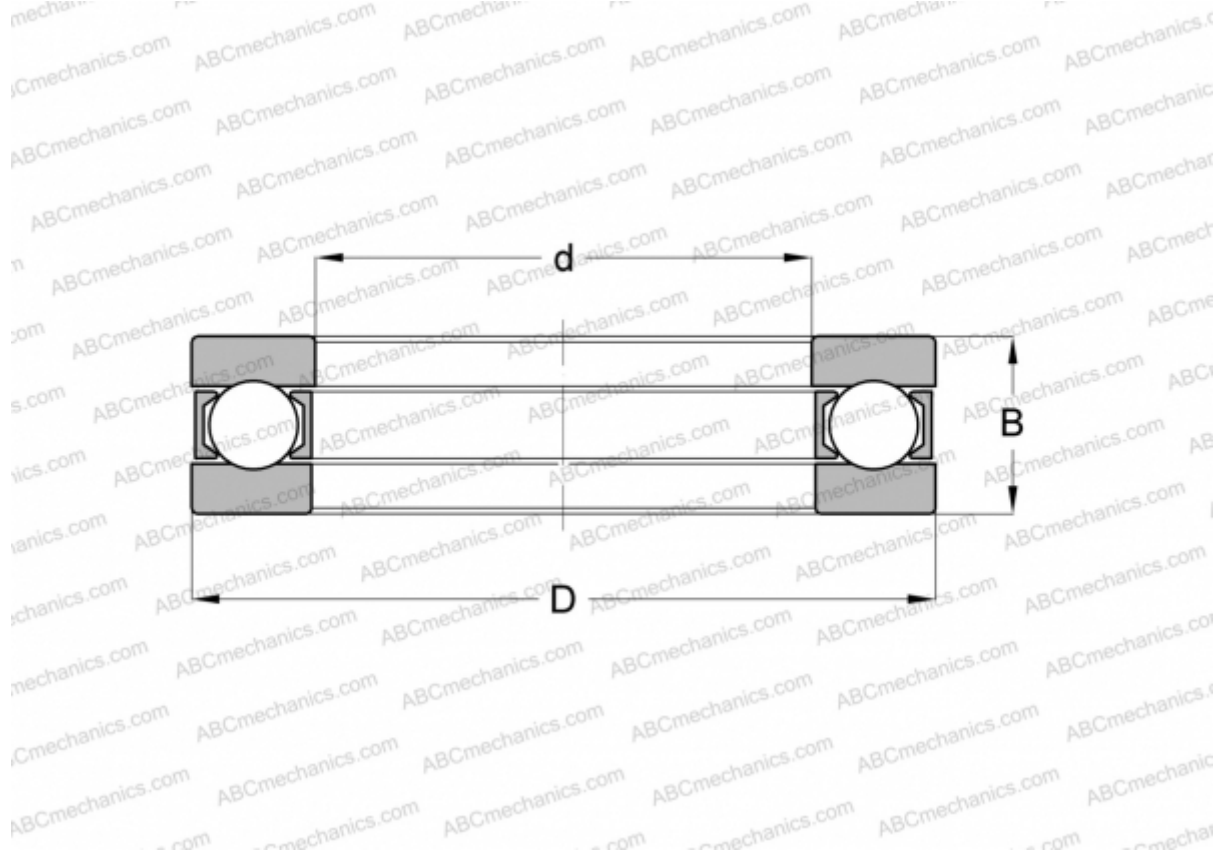

Technical specification

DIMENSIONS, MM

d	90,000
D	120,000
D1	90,200
D2	120,000
B	22,000

WEIGHT, KG 0,739

MANUFACTURER [INA](#)

INTERCHANGE

MRC	2918
SKF	2918