

2919 INA

Thrust ball bearings

TYPE: Ball bearings, Thrust ball bearing, Single direction, Separable, series 9/10/29/39

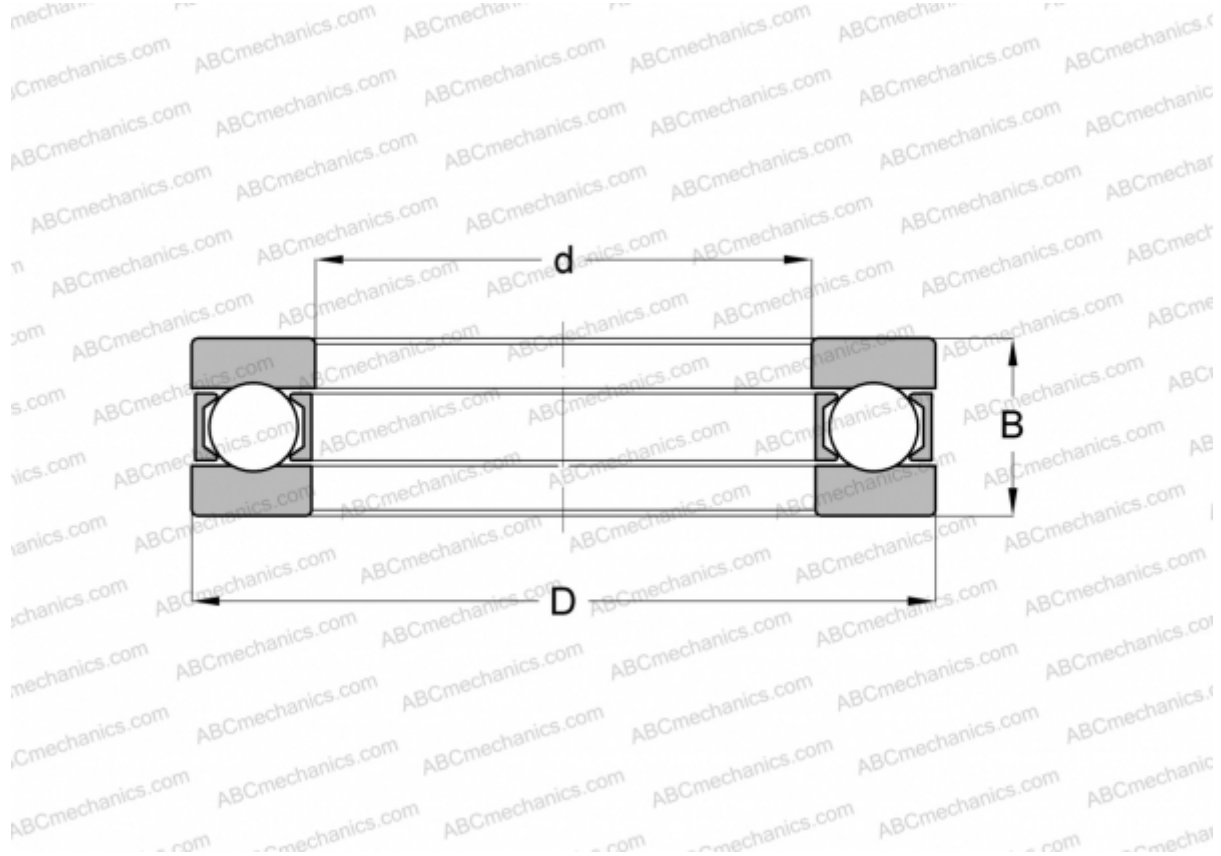

Technical specification

DIMENSIONS, MM

d	95,000
D	130,000
D1	95,200
D2	130,000
B	25,000

WEIGHT, KG 0,903

MANUFACTURER [INA](#)

INTERCHANGE

MRC	2919
SKF	2919