

2925 INA

Thrust ball bearings

TYPE: Ball bearings, Thrust ball bearing, Single direction, Separable, series 9/10/29/39

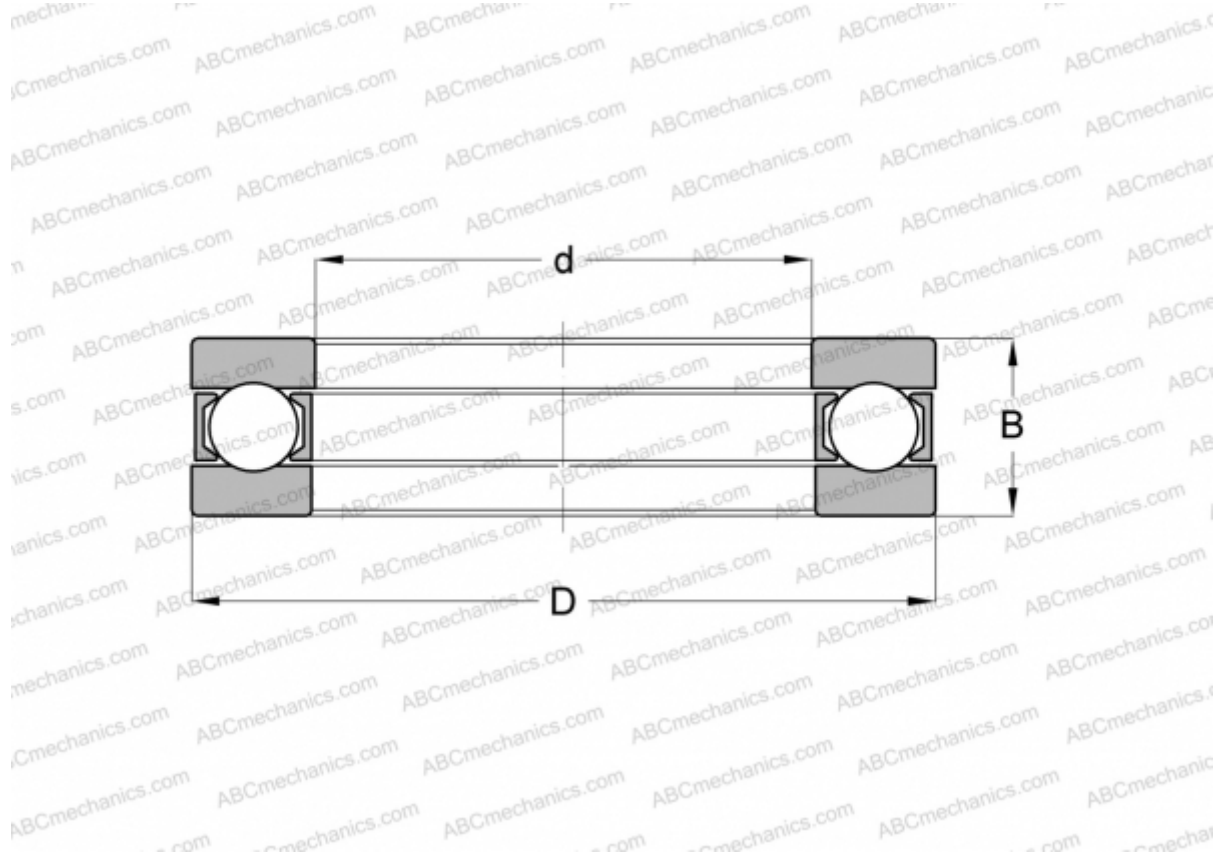

Technical specification

DIMENSIONS, MM

d	125,000
D	165,000
D1	125,200
D2	165,000
B	27,000

WEIGHT, KG 1,615

MANUFACTURER [INA](#)

INTERCHANGE

MRC	2925
SKF	2925