

3916 INA

Thrust ball bearings

TYPE: Ball bearings, Thrust ball bearing, Single direction, Separable, series 9/10/29/39

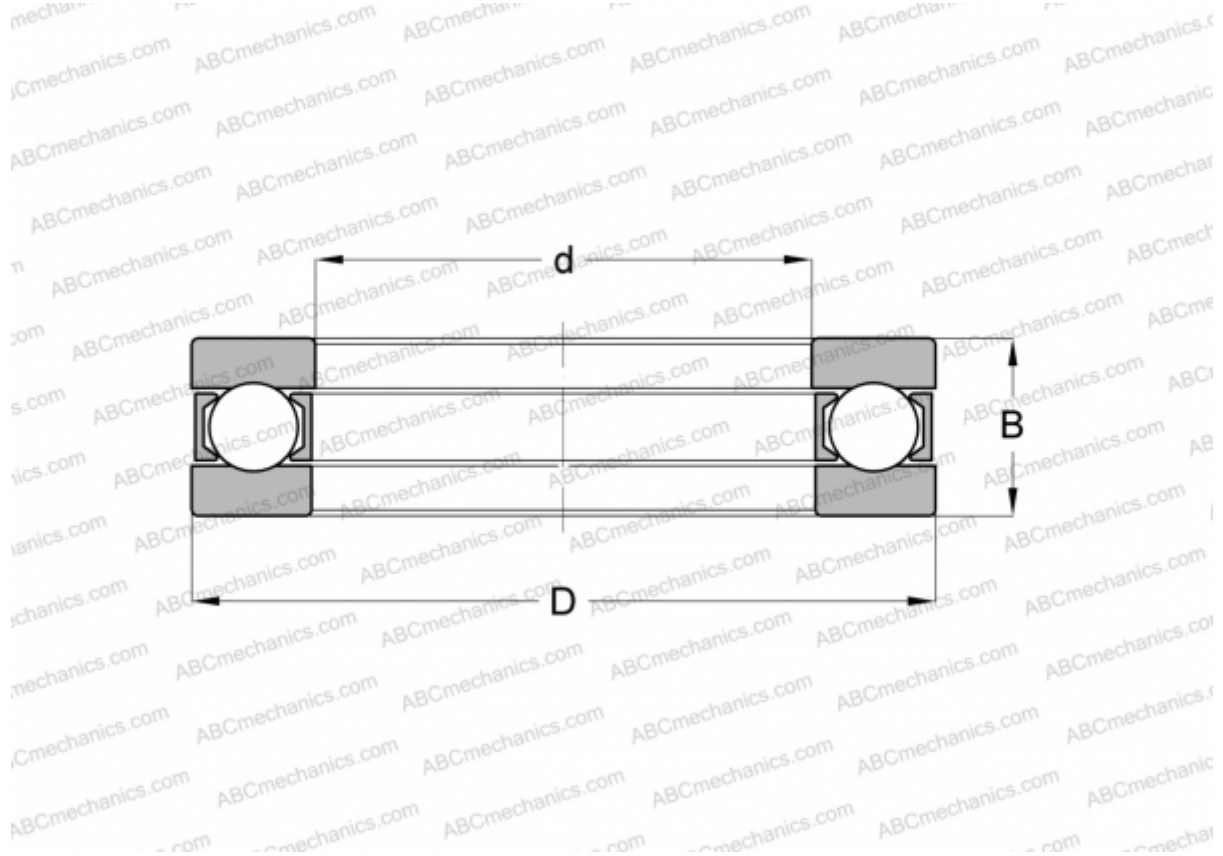

Technical specification

DIMENSIONS, MM

d	80,000
D	136,000
D1	80,200
D2	136,000
B	44,000

WEIGHT, KG 2,803

MANUFACTURER [INA](#)

INTERCHANGE

SKF [3916](#)