

3918 INA

Thrust ball bearings

TYPE: Ball bearings, Thrust ball bearing, Single direction, Separable, series 9/10/29/39

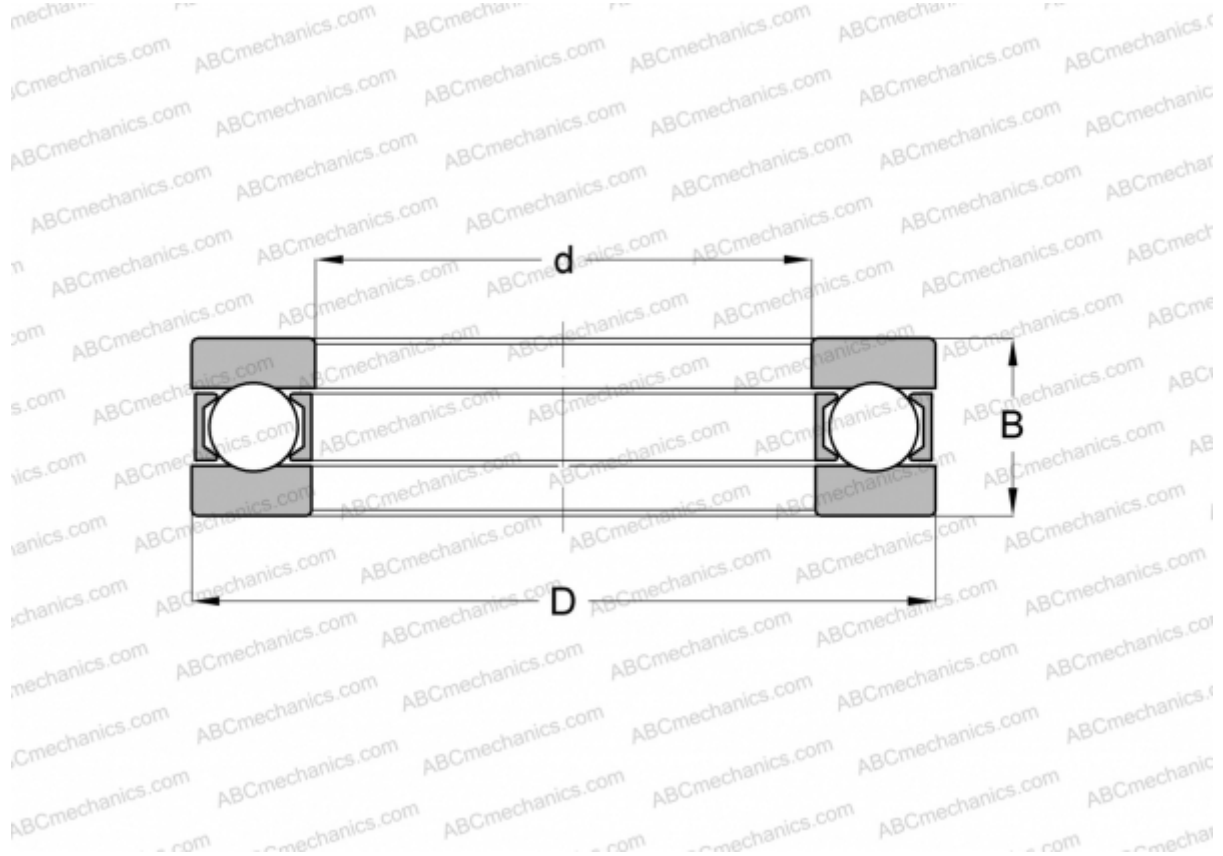

Technical specification

DIMENSIONS, MM

d	90,000
D	155,000
D1	90,200
D2	155,000
B	50,000

WEIGHT, KG 4,255

MANUFACTURER [INA](#)

INTERCHANGE

SKF [3918](#)