

## 908 INA

Thrust ball bearings

TYPE: Ball bearings, Thrust ball bearing, Single direction, Separable, series 9/10/29/39

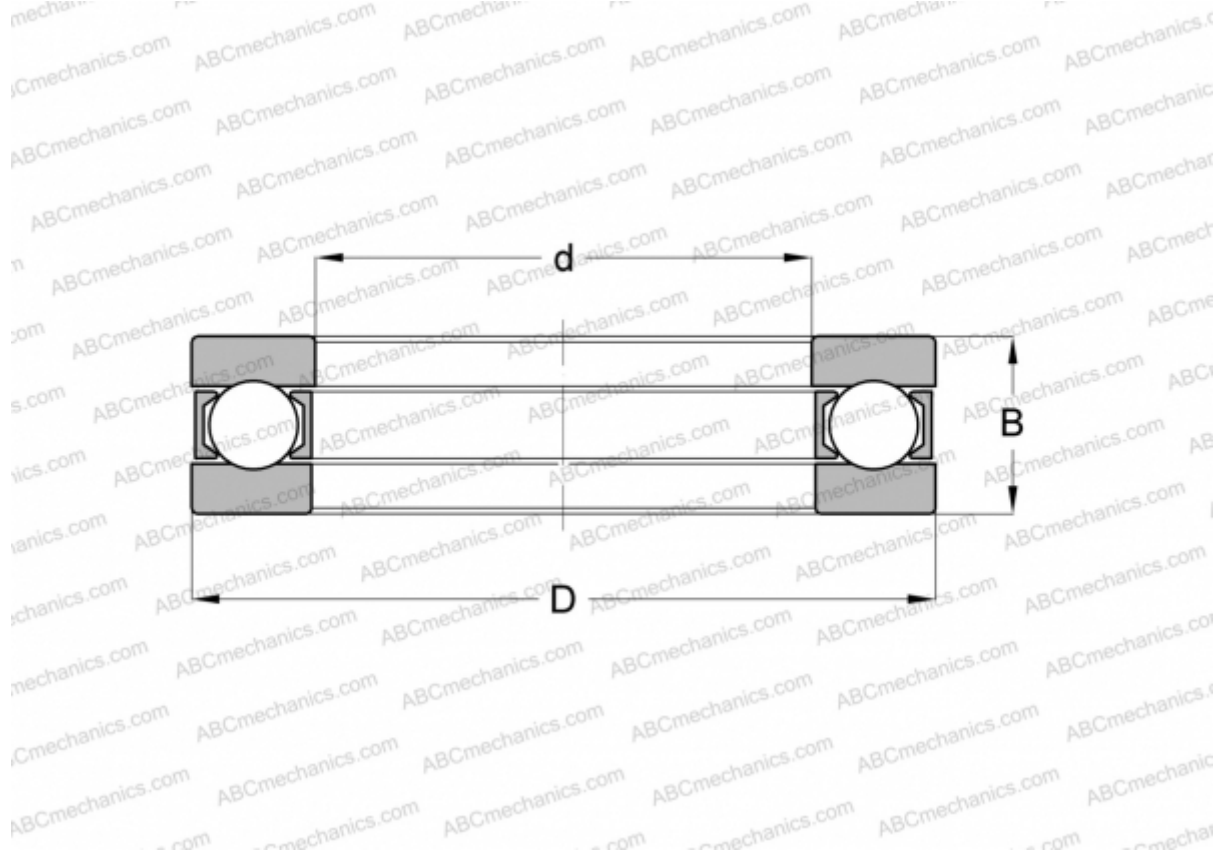

### Technical specification

#### DIMENSIONS, MM

d	40,000
D	64,000
D1	40,200
D2	64,000
B	18,000

**WEIGHT, KG** 0,213

**MANUFACTURER** [INA](#)

#### INTERCHANGE

MRC	<a href="#">1108F</a>
SKF	<a href="#">908</a>