

908 SKF

Thrust ball bearings

TYPE: Ball bearings, Thrust ball bearing, Single direction, Separable, series 9/10/29/39

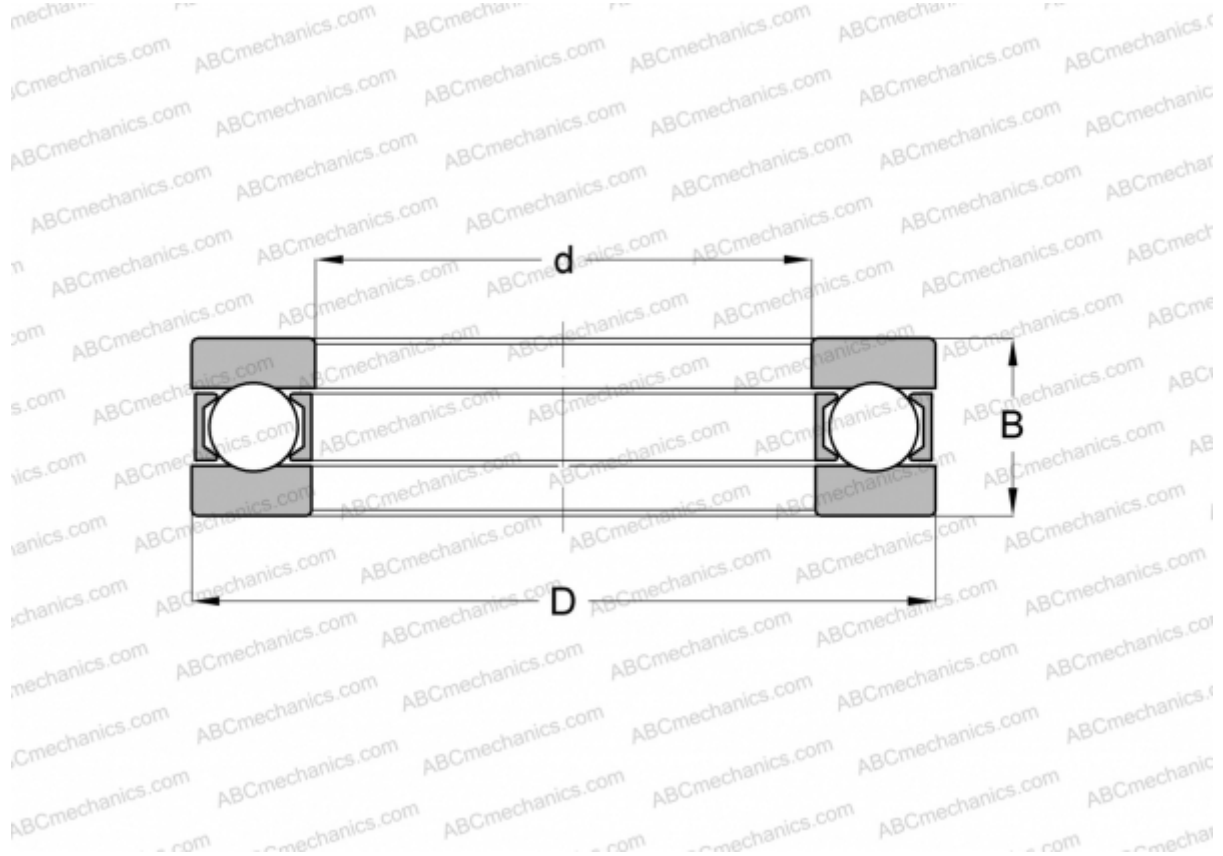

Technical specification

DIMENSIONS, MM

d	40,000
D	64,000
D1	40,200
D2	64,000
B	18,000

WEIGHT, KG 0,213

MANUFACTURER [SKF](#)

INTERCHANGE

INA	908
MRC	1108F