

912 SKF

Thrust ball bearings

TYPE: Ball bearings, Thrust ball bearing, Single direction, Separable, series 9/10/29/39

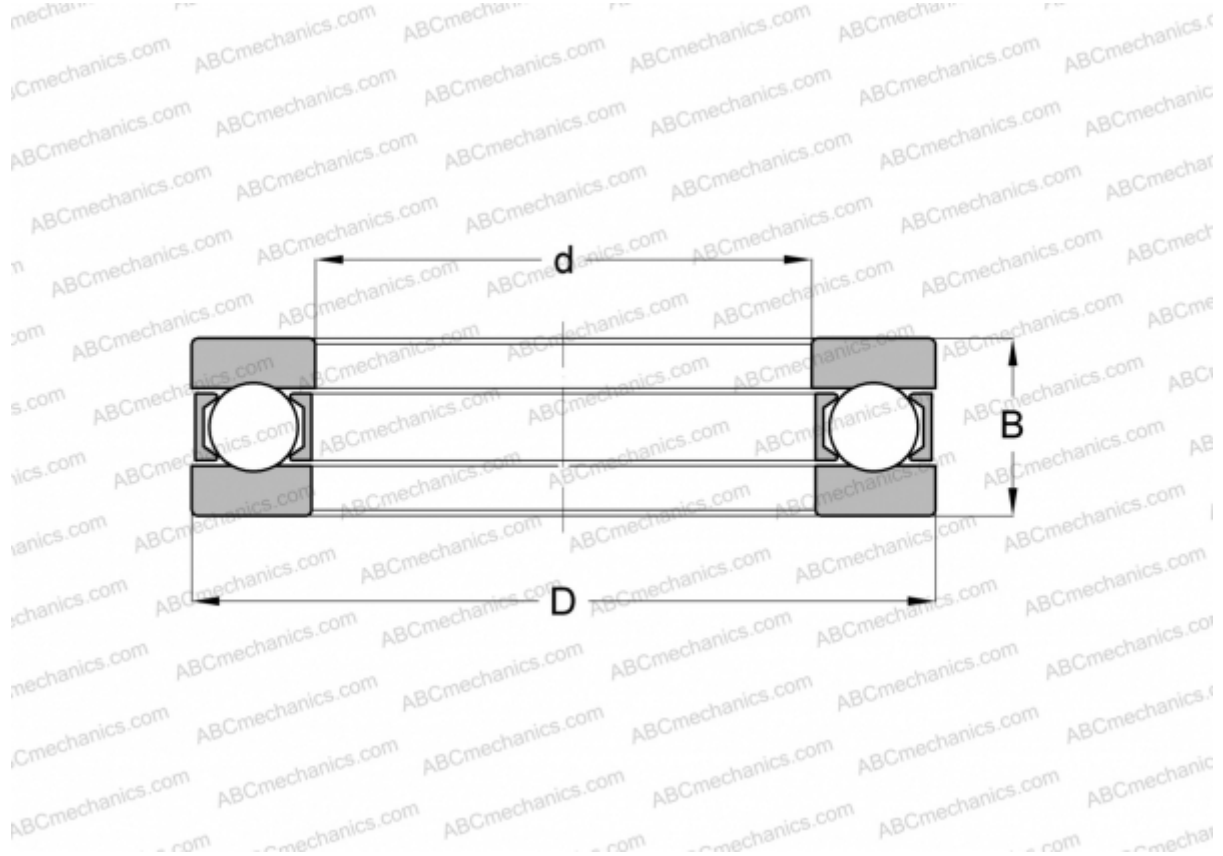

Technical specification

DIMENSIONS, MM

d	60,000
D	90,000
D1	60,200
D2	90,000
B	24,500

WEIGHT, KG 0,517

MANUFACTURER [SKF](#)

INTERCHANGE

INA	912
MRC	1112F2