

## 928 INA

Thrust ball bearings

TYPE: Ball bearings, Thrust ball bearing, Single direction, Separable, series 9/10/29/39

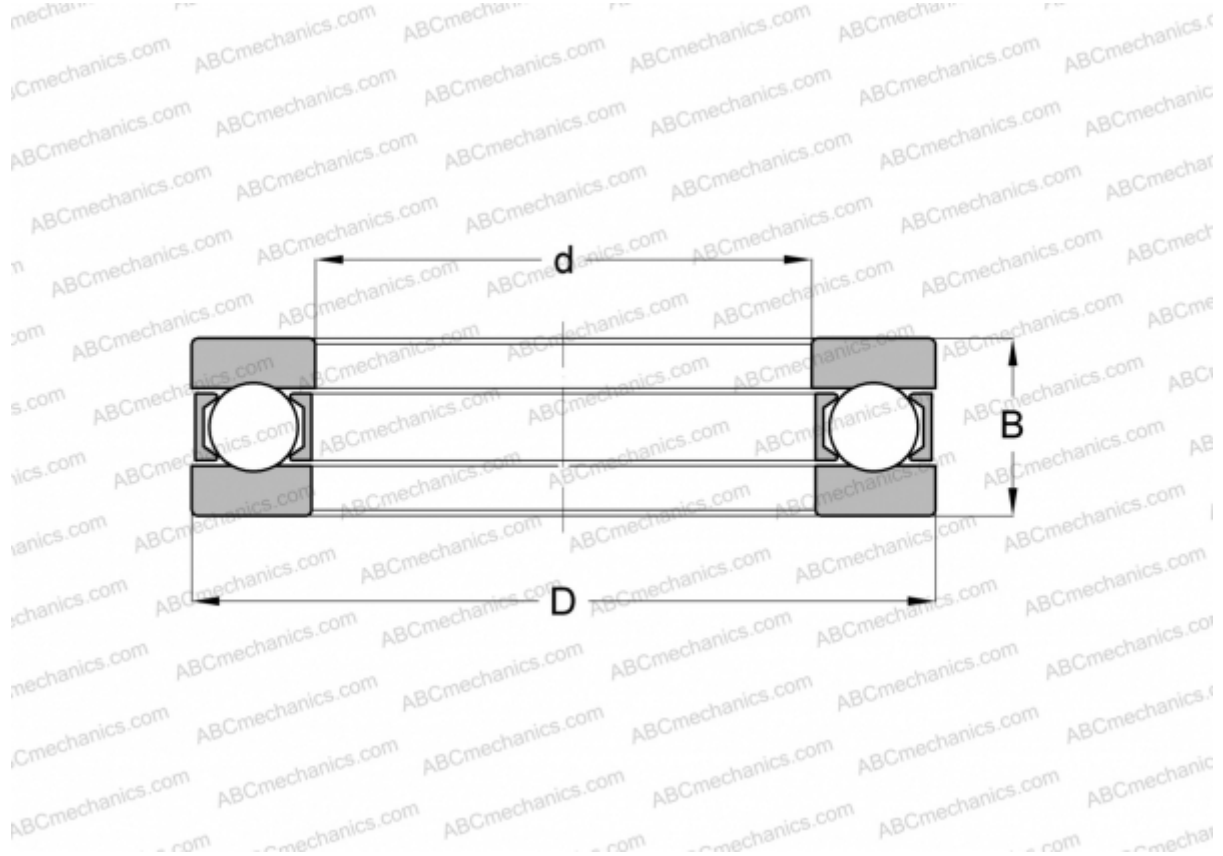

### Technical specification

#### DIMENSIONS, MM

d	140,000
D	200,000
D1	140,200
D2	200,000
B	52,000

**WEIGHT, KG** 5,103

**MANUFACTURER** [INA](#)

#### INTERCHANGE

MRC	<a href="#">1128F</a>
SKF	<a href="#">928</a>