

4305 FAFNIR

Thrust ball bearings

TYPE: Ball bearings, Thrust ball bearing, Single direction, Separable, inch size

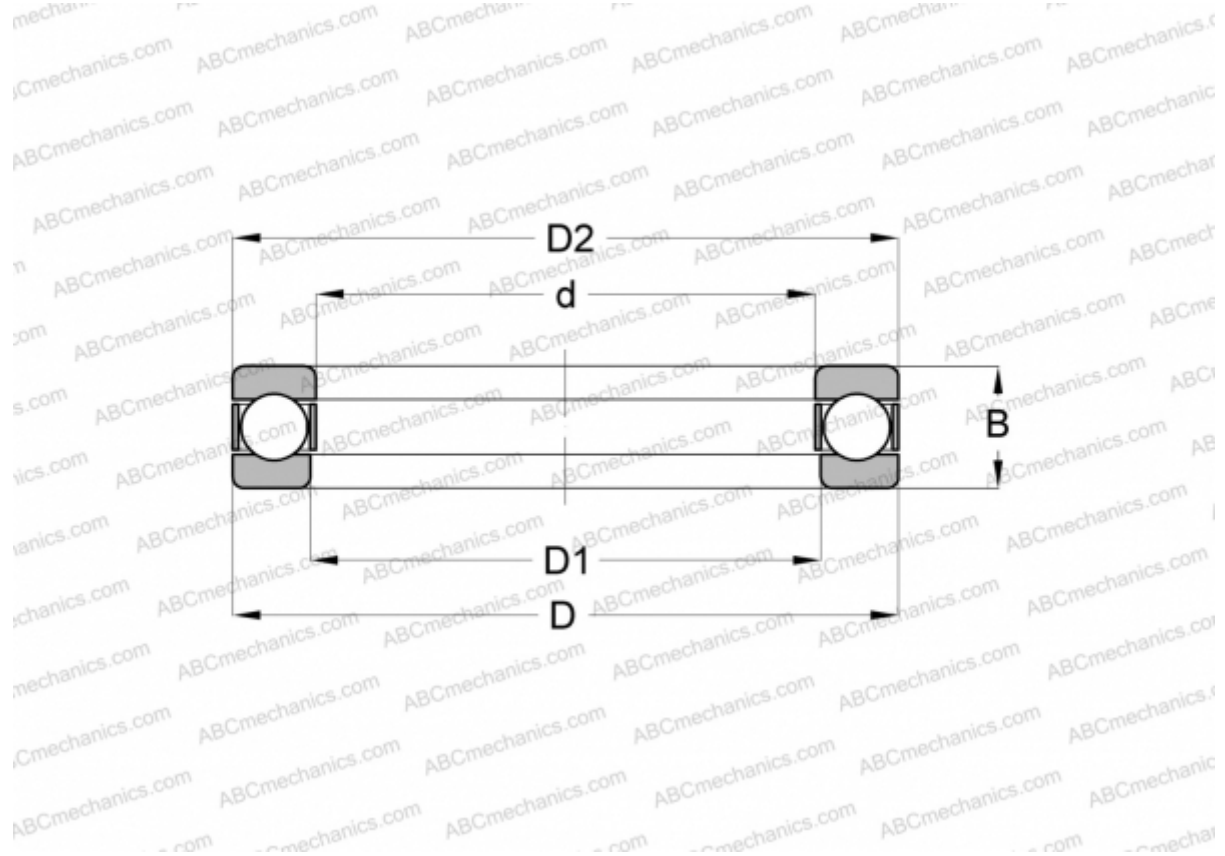

Technical specification

DIMENSIONS, MM

d	15,875
D	35,718
D1	16,668
D2	34,925
B	15,875

WEIGHT, KG 0,086

MANUFACTURER [FAFNIR](#)

INTERCHANGE

ABC	W- 5/8
INA	W- 5/8
FBC	W- 5/8
MRC	2-B
RHP	LT- 5/8 B

INTERCHANGE

SKF	0-5
-----	---------------------