

4312 FAFNIR

Thrust ball bearings

TYPE: Ball bearings, Thrust ball bearing, Single direction, Separable, inch size

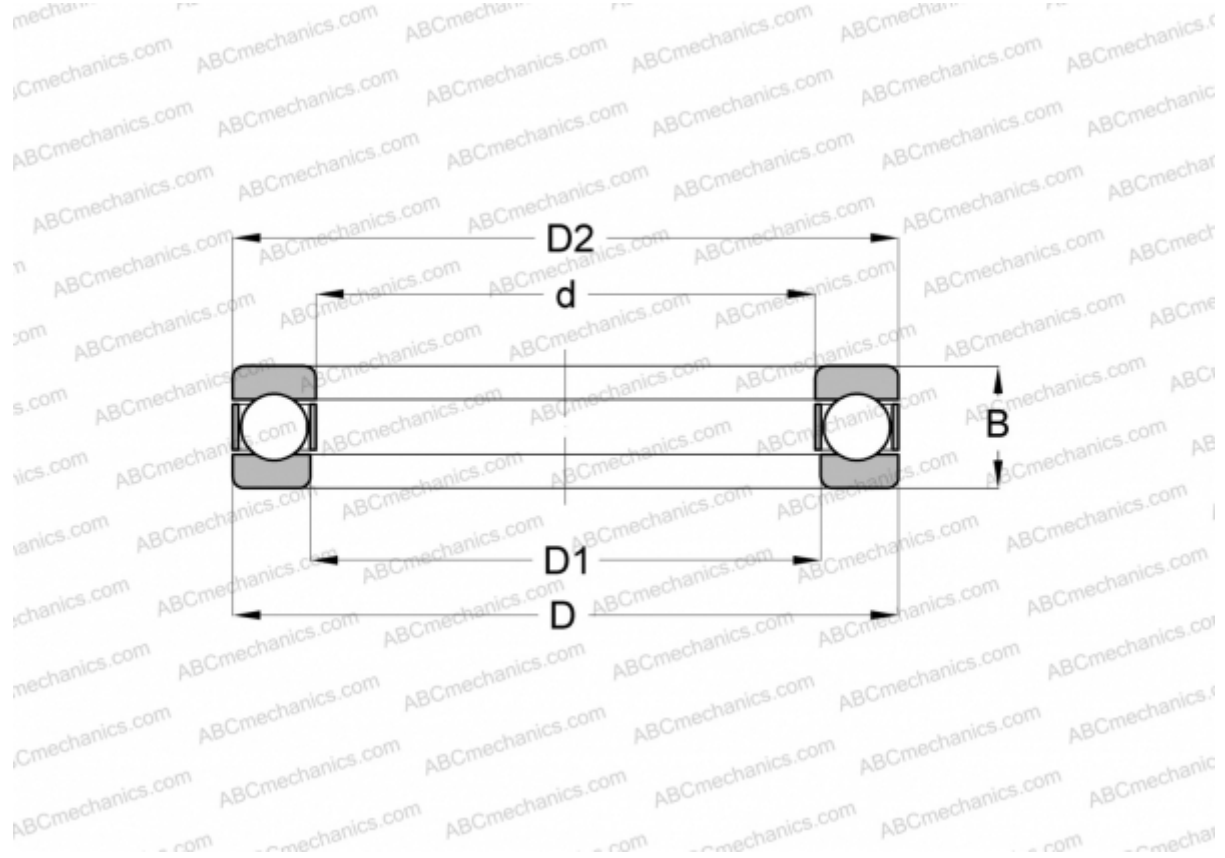

Technical specification

DIMENSIONS, MM

d	38,100
D	59,530
D1	38,893
D2	58,738
B	18,255

WEIGHT, KG 0,195

MANUFACTURER [FAFNIR](#)

INTERCHANGE

ABC	W-1 1/2
INA	W-1 1/2
FBC	W-1 1/2
MRC	9-B
RHP	LT-1 1/2 B

INTERCHANGE

SKF	0-12
-----	----------------------