

## HW- 1/4 INA

Thrust ball bearings

TYPE: Ball bearings, Thrust ball bearing, Single direction, Separable, inch size

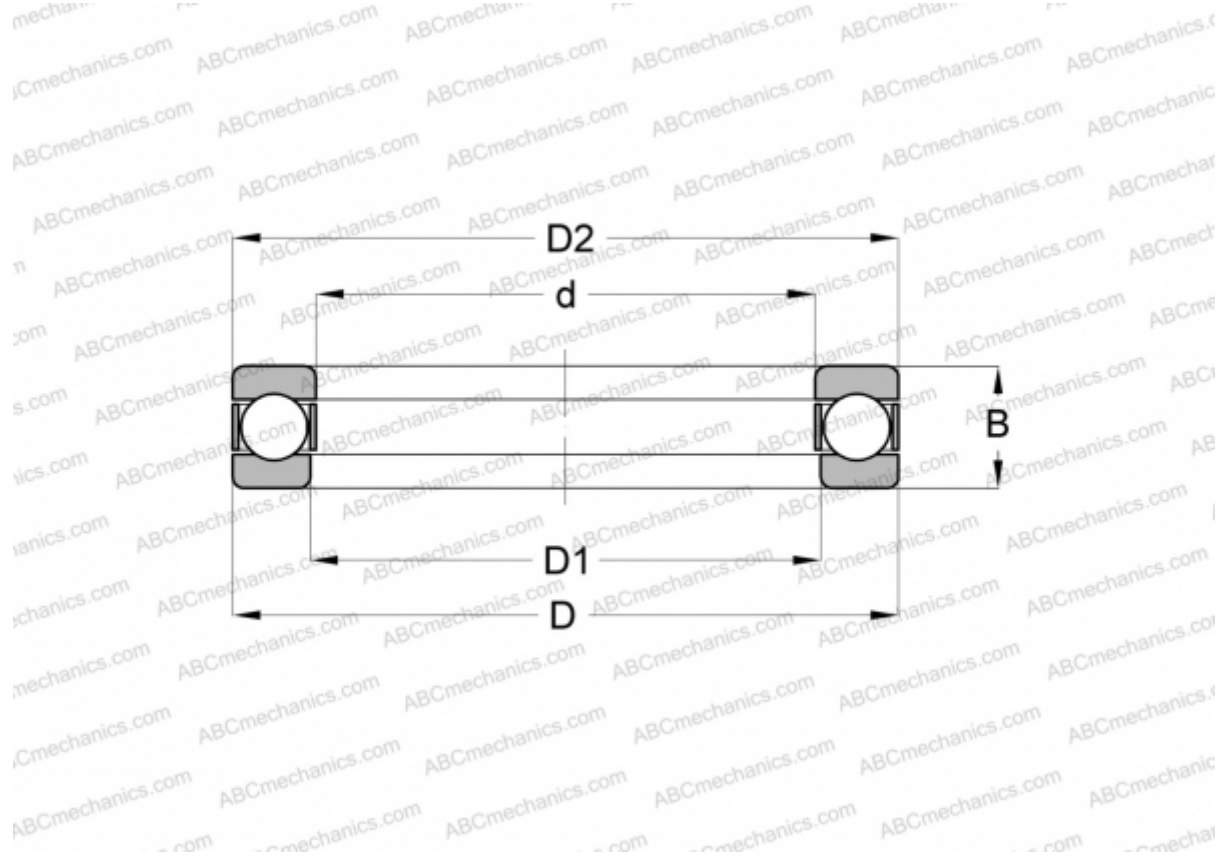

### Technical specification

#### DIMENSIONS, MM

d	6,350
D	23,813
D1	7,938
D2	22,225
B	13,493

**WEIGHT, KG** 0,032

**MANUFACTURER** [INA](#)

#### INTERCHANGE

ABC	<a href="#">HW- 1/4</a>
NORMA HOFFMAN	<a href="#">HW- 1/4</a>
RHP	<a href="#">HT- 1/4</a>
SKF	<a href="#">VH-2</a>