

4402 INA

Thrust ball bearings

TYPE: Ball bearings, Thrust ball bearing, Single direction, Separable, inch size

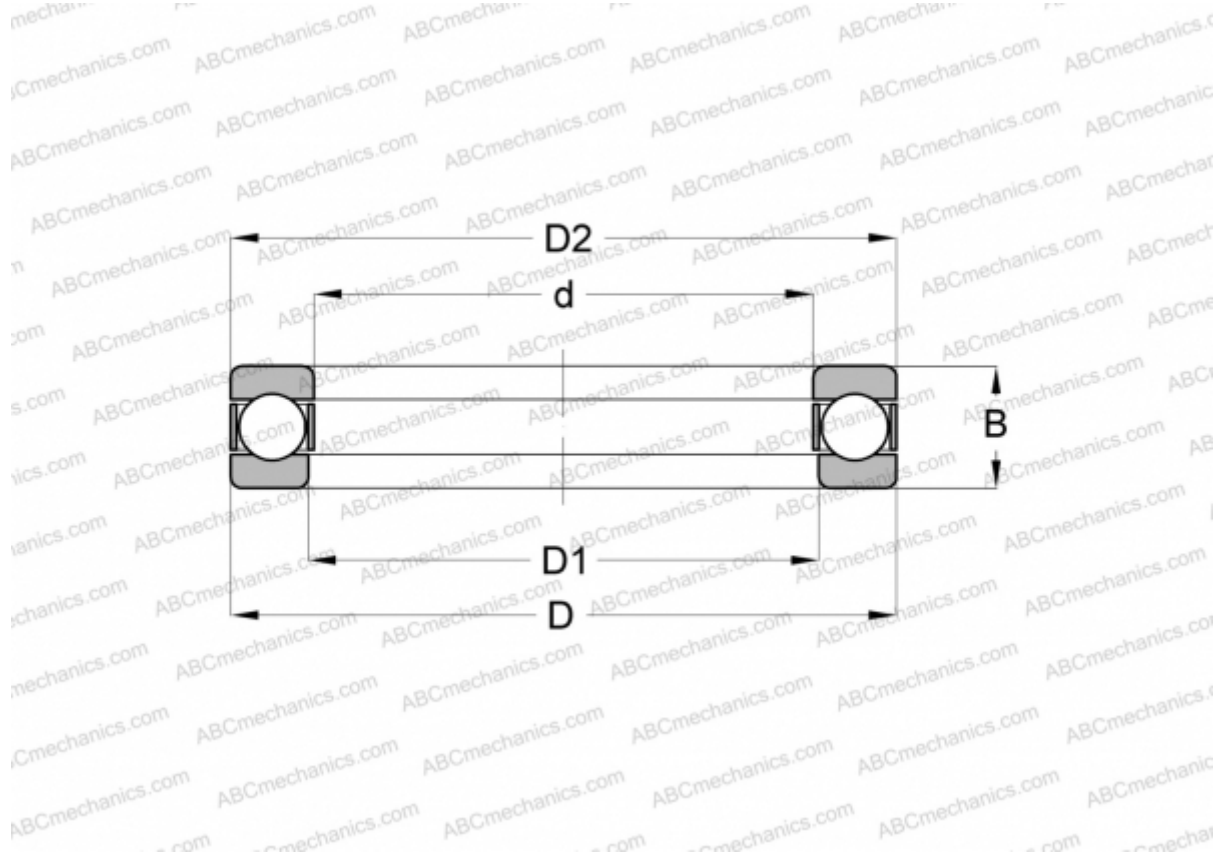

Technical specification

DIMENSIONS, MM

d	14,288
D	36,513
D1	15,088
B	15,875

WEIGHT, KG 0,084

MANUFACTURER [INA](#)

INTERCHANGE

ABC	4402
AETNA	G-2
ANDREWS	4402