

4404 INA

Thrust ball bearings

TYPE: Ball bearings, Thrust ball bearing, Single direction, Separable, inch size

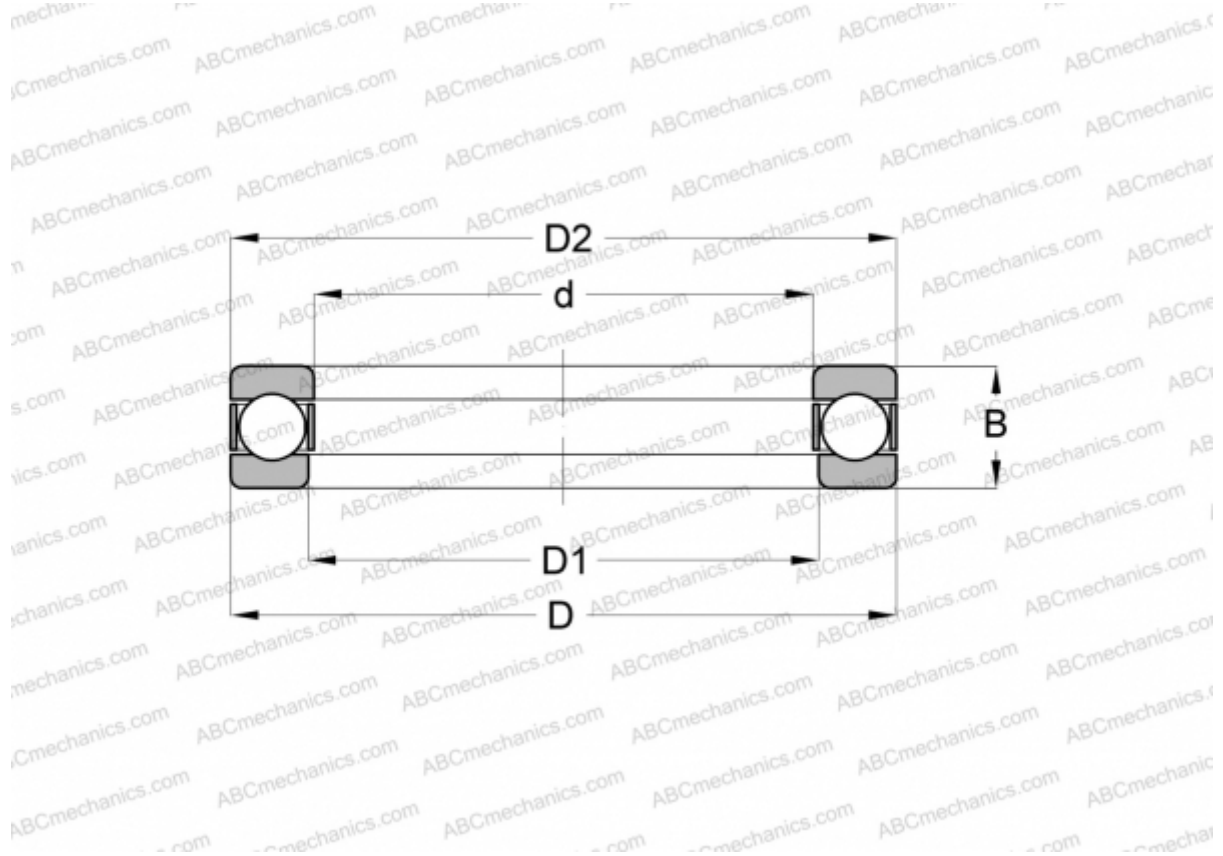

Technical specification

DIMENSIONS, MM

d	17,463
D	39,688
D1	18,263
B	15,875

WEIGHT, KG 0,096

MANUFACTURER [INA](#)

INTERCHANGE

ABC	4404
AETNA	G-4
ANDREWS	4404