

G-8 AETNA

Thrust ball bearings

TYPE: Ball bearings, Thrust ball bearing, Single direction, Separable, inch size

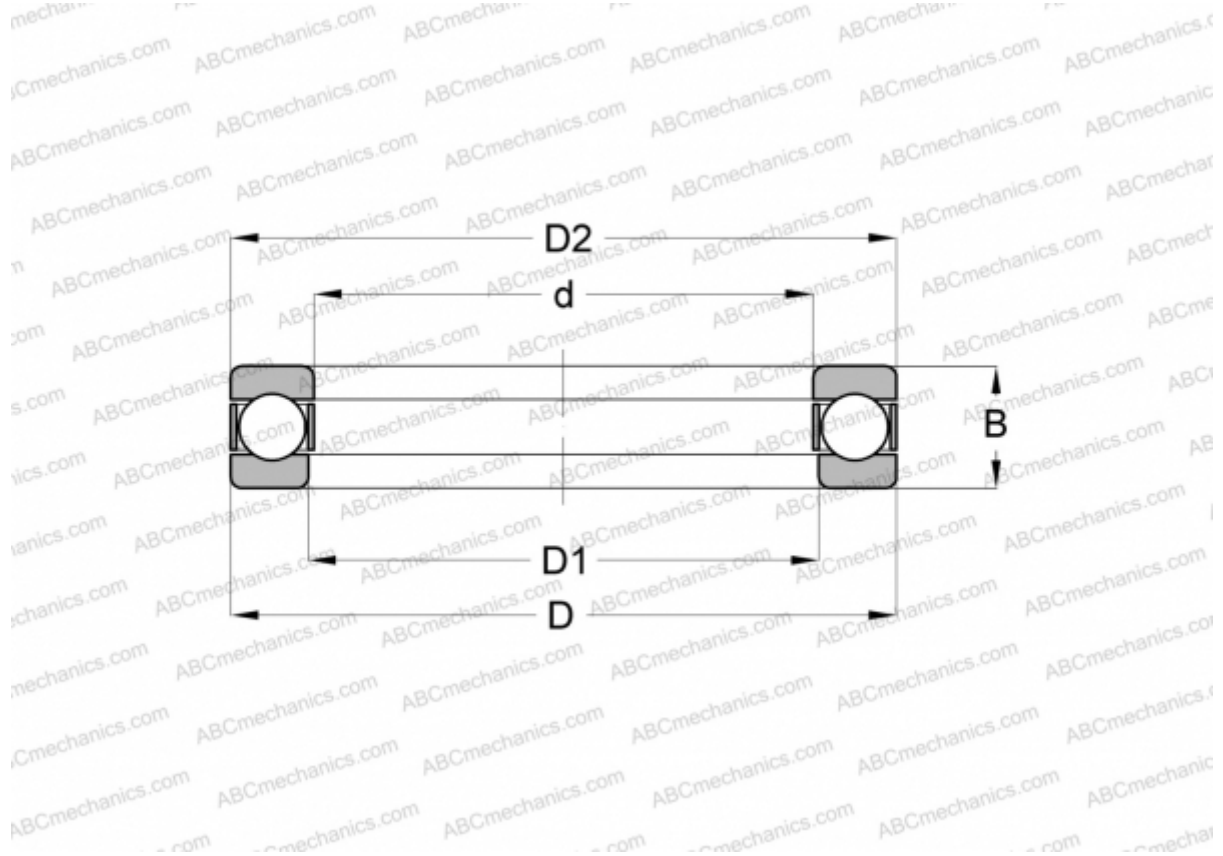

Technical specification

DIMENSIONS, MM

d	23,813
D	49,213
D1	24,613
B	19,050

WEIGHT, KG 0,171

MANUFACTURER [AETNA](#)

INTERCHANGE

ABC	4408
INA	4408
ANDREWS	4408