

G-11 AETNA

Thrust ball bearings

TYPE: Ball bearings, Thrust ball bearing, Single direction, Separable, inch size

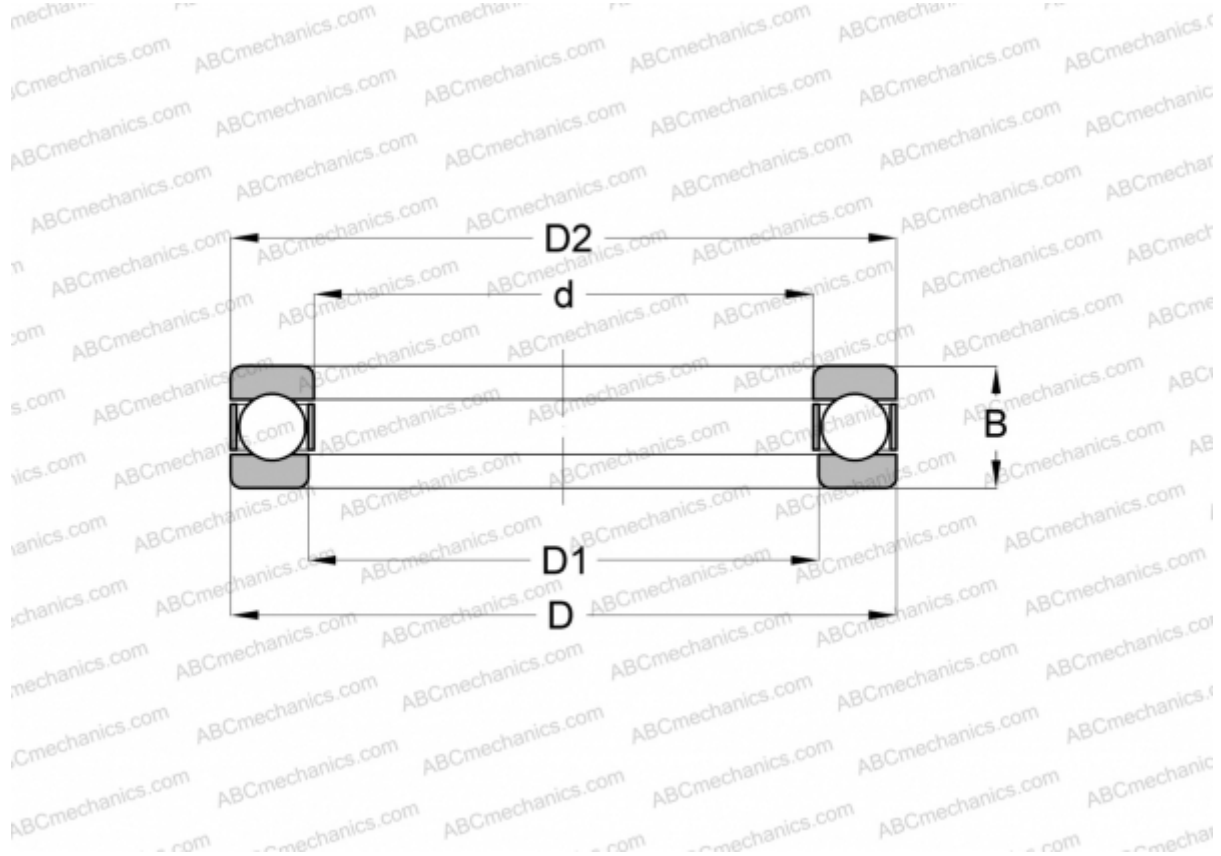

Technical specification

DIMENSIONS, MM

d	28,575
D	55,563
D1	29,362
B	19,050

WEIGHT, KG 0,206

MANUFACTURER [AETNA](#)

INTERCHANGE

ABC	4411
INA	4411
ANDREWS	4411