

4415 INA

Thrust ball bearings

TYPE: Ball bearings, Thrust ball bearing, Single direction, Separable, inch size

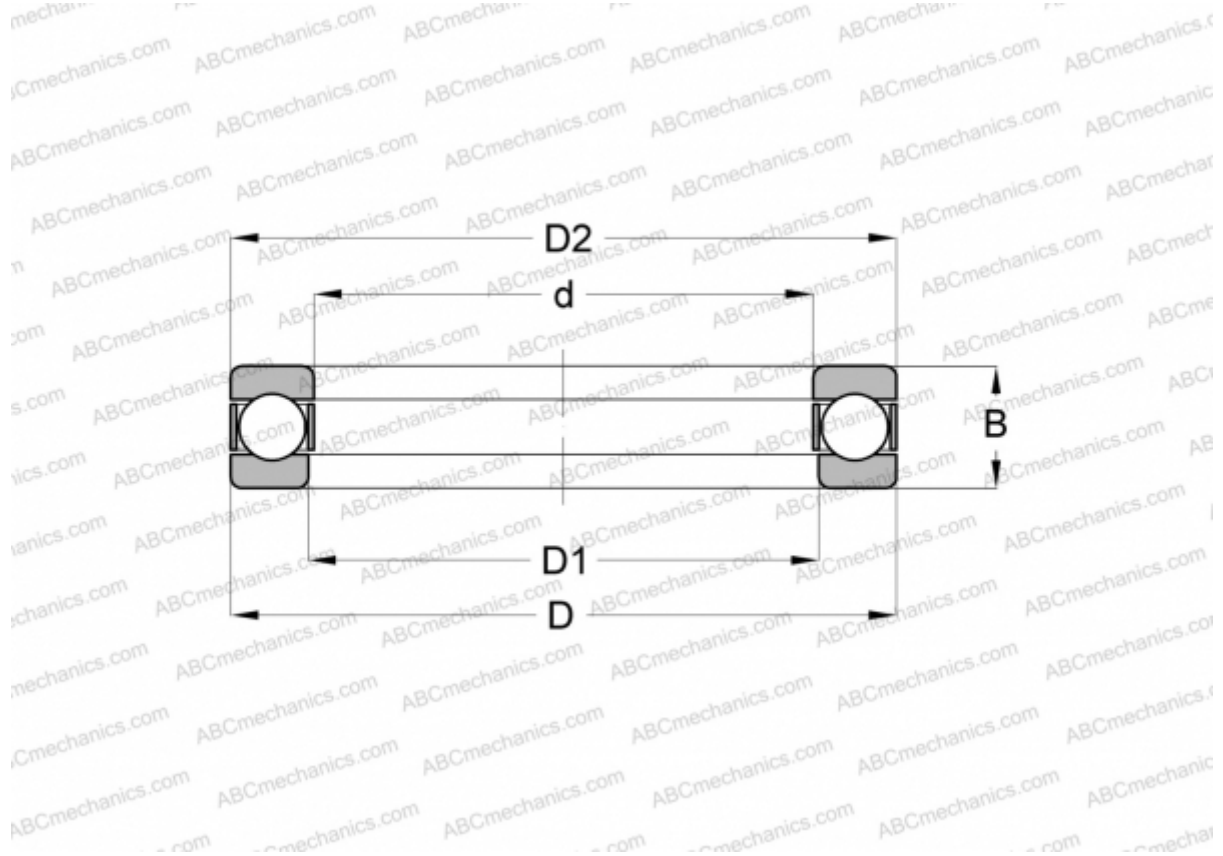

Technical specification

DIMENSIONS, MM

d	34,925
D	61,913
D1	35,712
B	19,050

WEIGHT, KG 0,231

MANUFACTURER [INA](#)

INTERCHANGE

ABC	4415
AETNA	G-15
ANDREWS	4415