

4418 ABC

Thrust ball bearings

TYPE: Ball bearings, Thrust ball bearing, Single direction, Separable, inch size

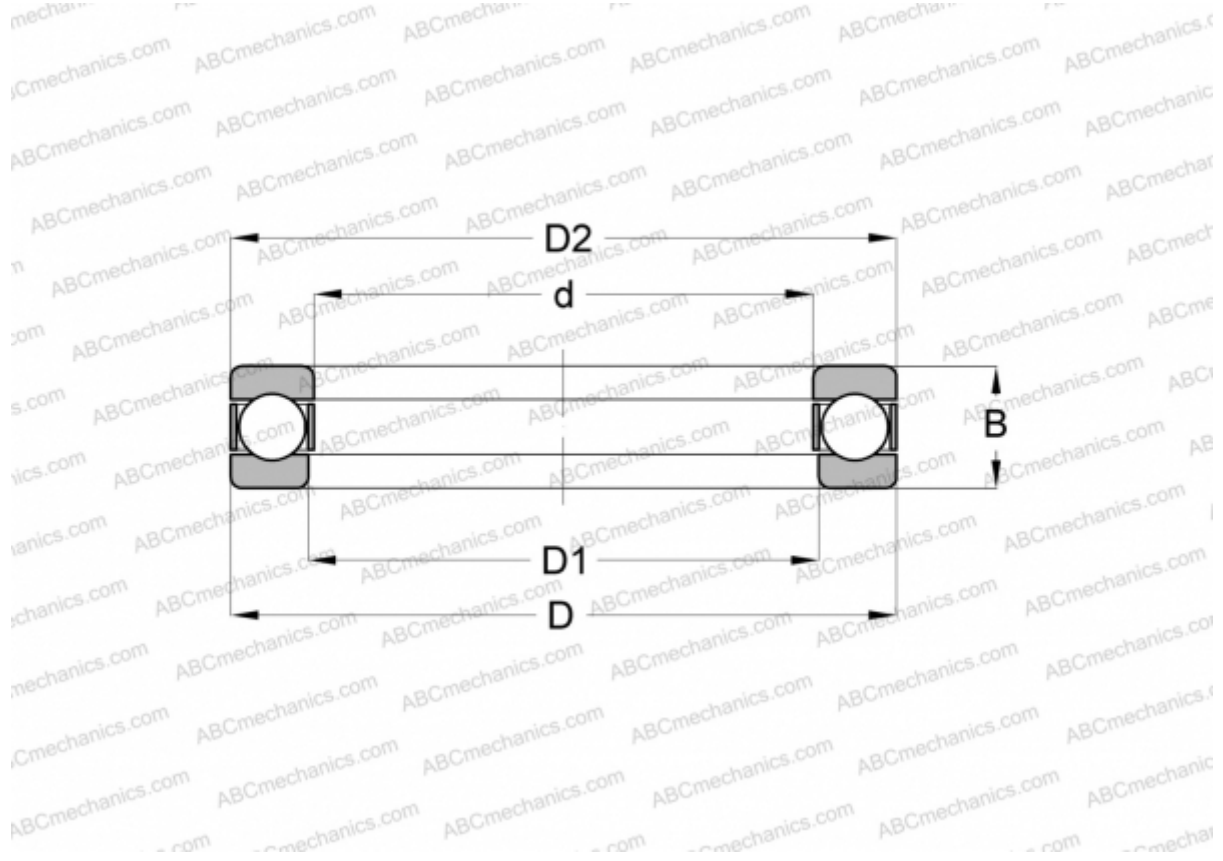

Technical specification

DIMENSIONS, MM

d	39,688
D	65,088
D1	40,488
B	19,050

WEIGHT, KG 0,242

MANUFACTURER [ABC](#)

INTERCHANGE

INA	4418
AETNA	G-18
ANDREWS	4418