

F-1 AETNA

Thrust ball bearings

TYPE: Ball bearings, Thrust ball bearing, Single direction, Separable, inch size

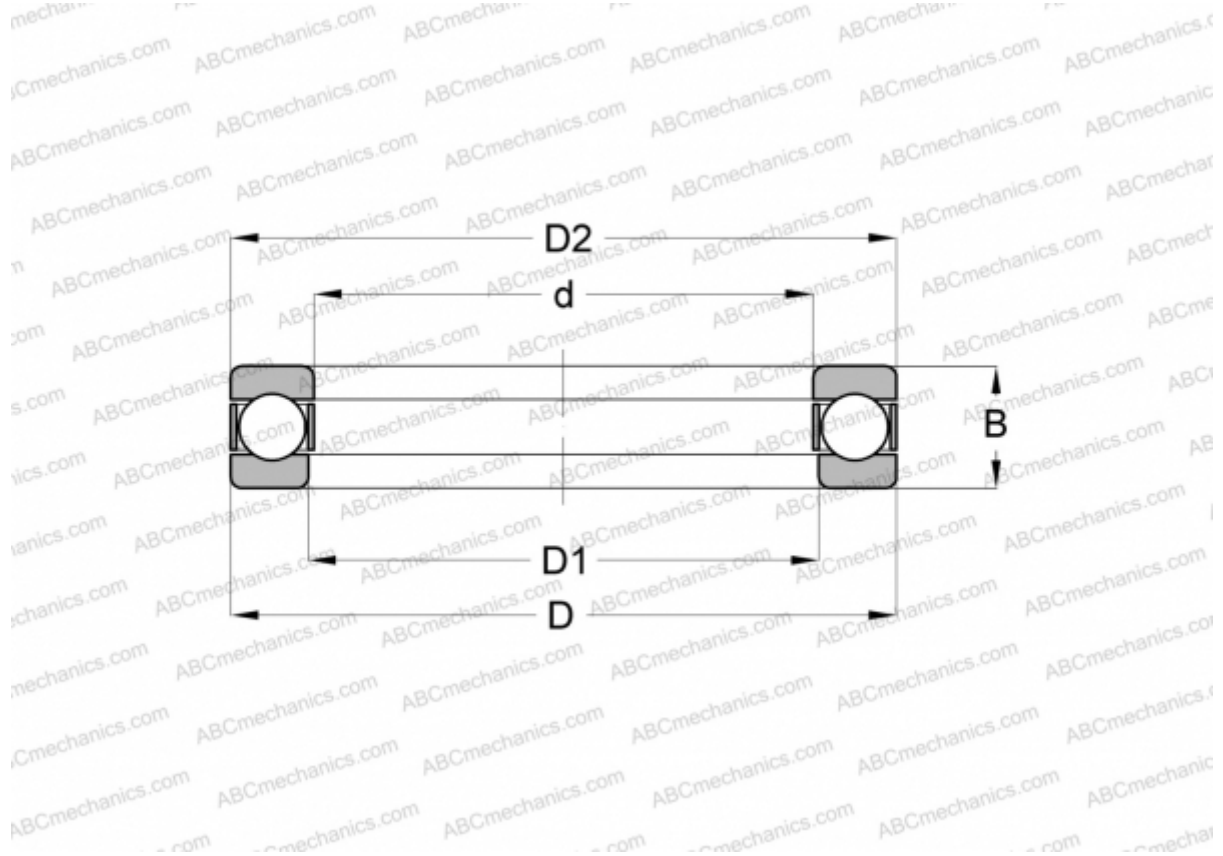

Technical specification

DIMENSIONS, MM

d	12,700
D	30,955
D1	13,493
B	14,288

WEIGHT, KG 0,057

MANUFACTURER [AETNA](#)

INTERCHANGE

ABC	GT-1
INA	GT-1
ANDREWS	GT-1
NICE	1001