

GT-5 ABC

Thrust ball bearings

TYPE: Ball bearings, Thrust ball bearing, Single direction, Separable, inch size

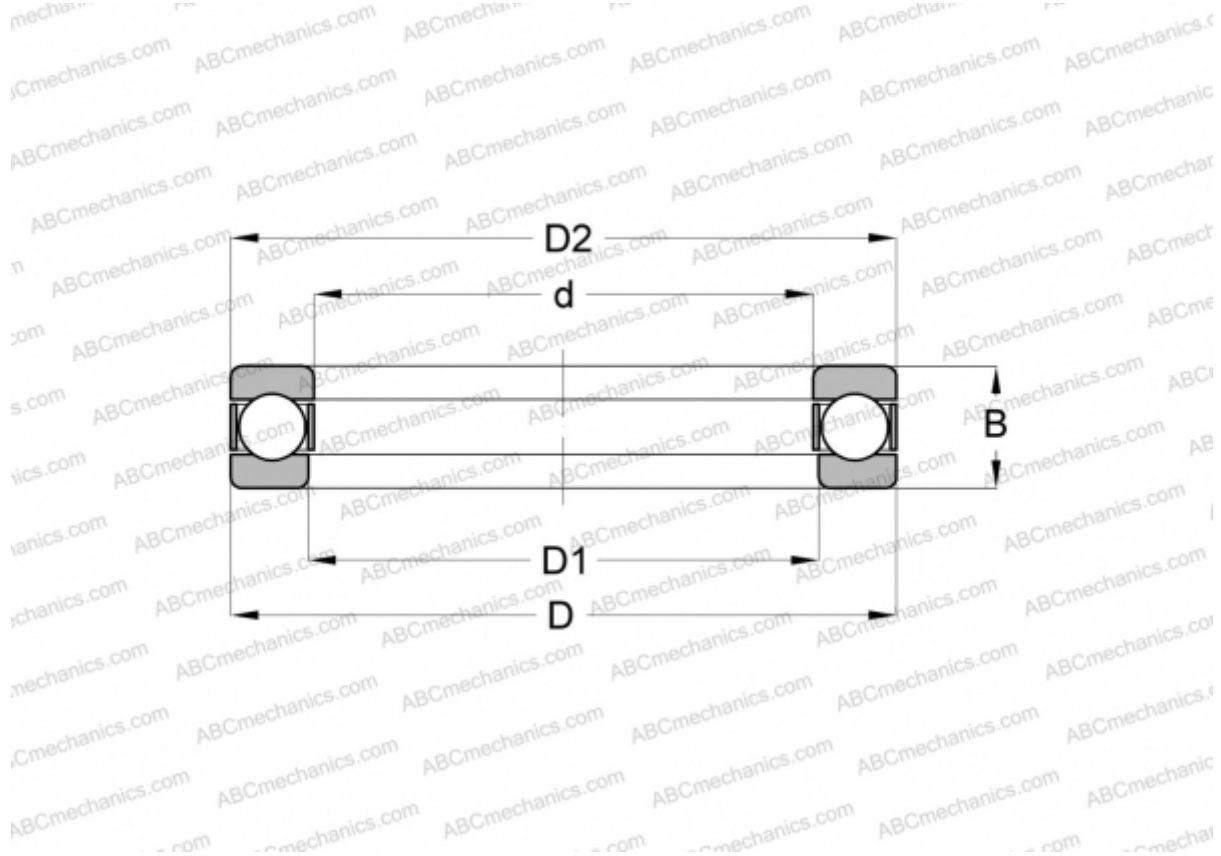

Technical specification

DIMENSIONS, MM

d	19,050
D	37,305
D1	19,843
B	14,288

WEIGHT, KG 0,074

MANUFACTURER [ABC](#)

INTERCHANGE

INA	GT-5
AETNA	F-5
ANDREWS	GT-5